

OUR **IMPLANT SYSTEMS**  
RELIABLE, EFFICIENT, SAFE

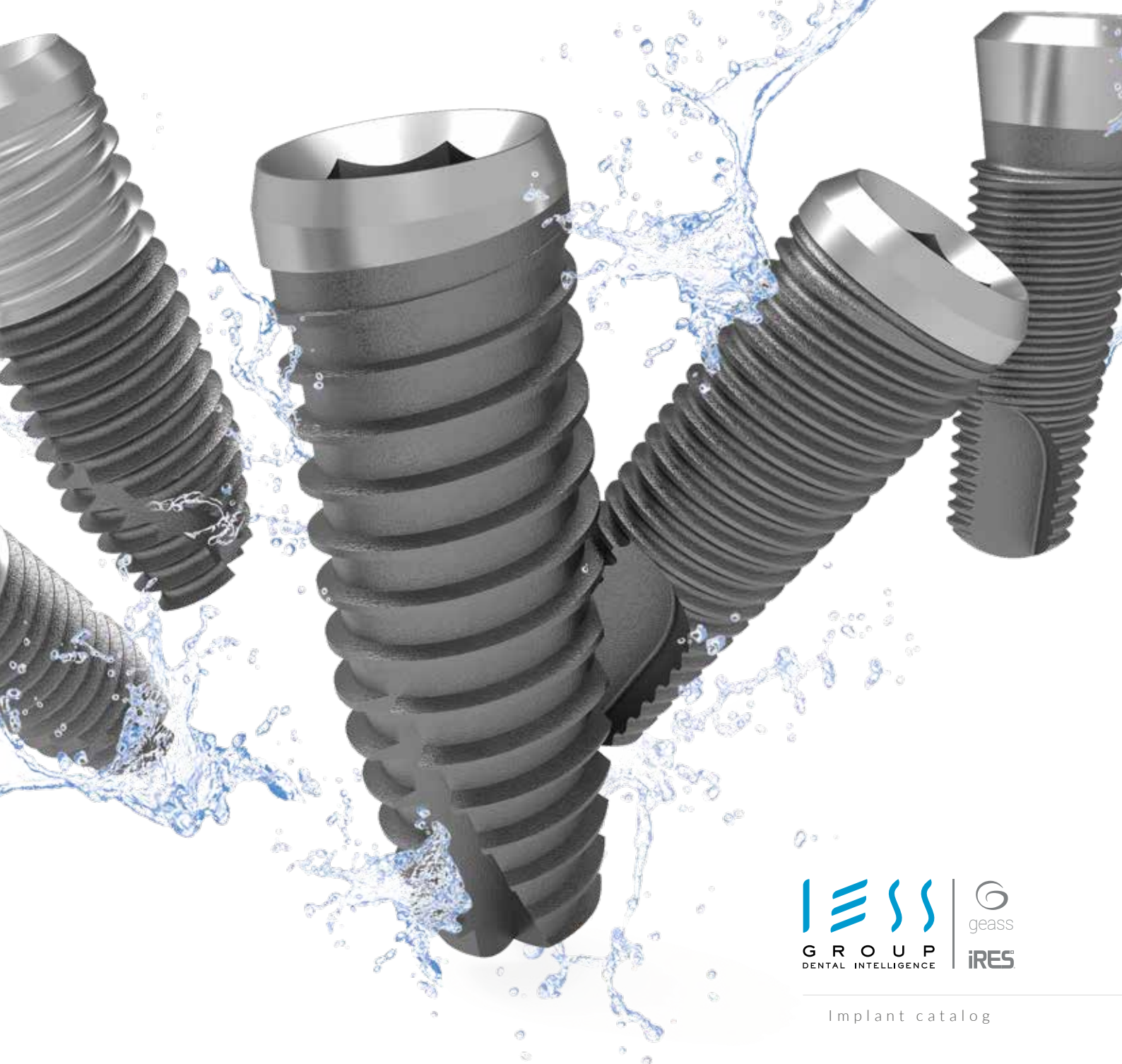

**iRES**<sup>+</sup>

Swiss  
implant  
quality

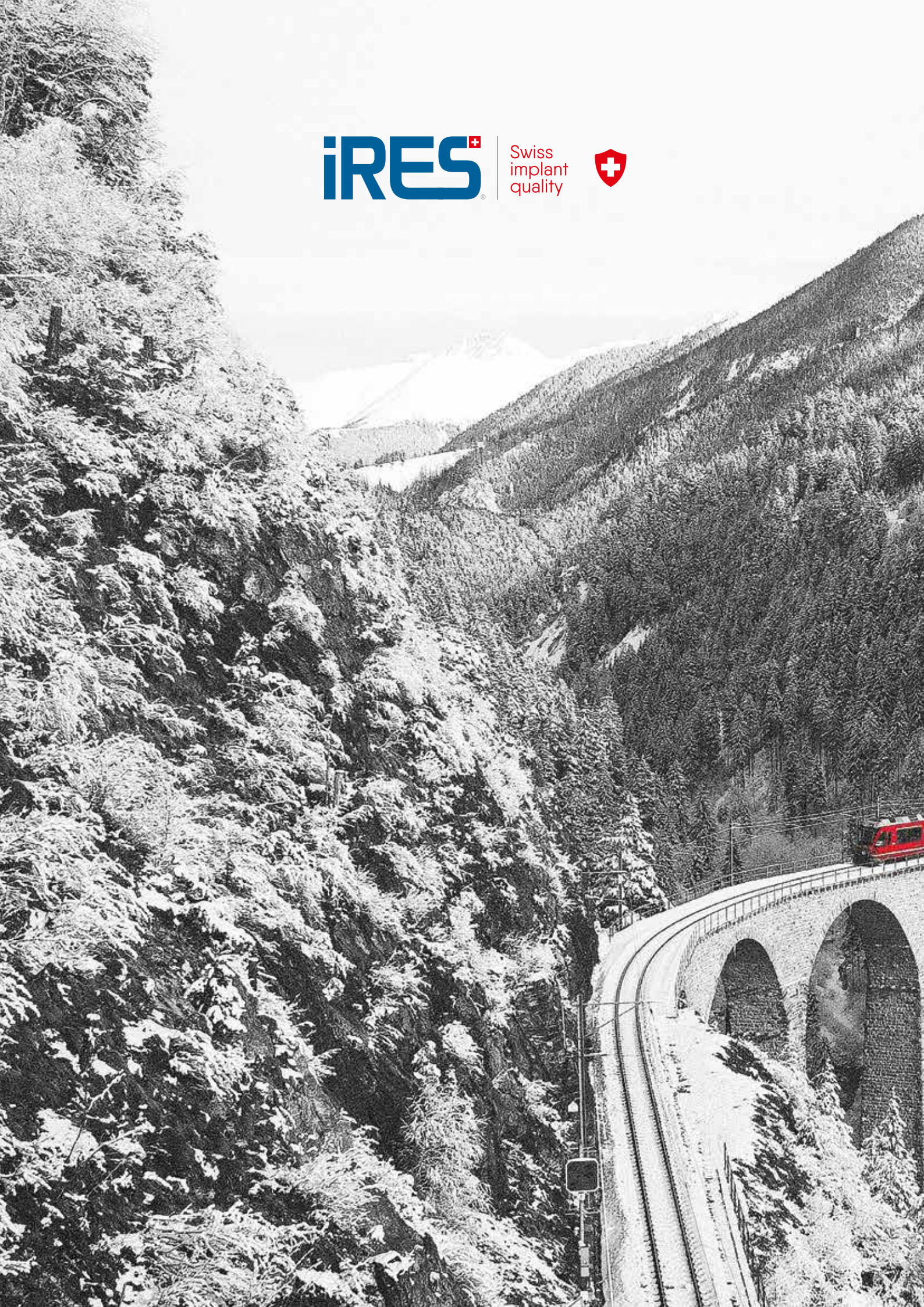



# OUR IMPLANT SYSTEMS

---

Reliable  
Efficient  
Safe

## SHAPEONE

---

■ Internal hex  $\varnothing$  3.7 - 4.1 - 4.7

## VOLUTION

---

■ Internal hex  $\varnothing$  3.3 - 3.7 - 4.1 - 4.7 - 5.2

## iMAX

---

■ Internal hex  $\varnothing$  3.3 - 3.7 - 4.1 - 4.7 - 5.2  
■ External hex  $\varnothing$  3.3 - 3.7 - 4.1 - 4.7 - 5.2

## iMAX *NHSIC*

---

■ Cono-morse narrow  $\varnothing$  3.3 - 3.7 - 4.1 - 4.7 - 5.2

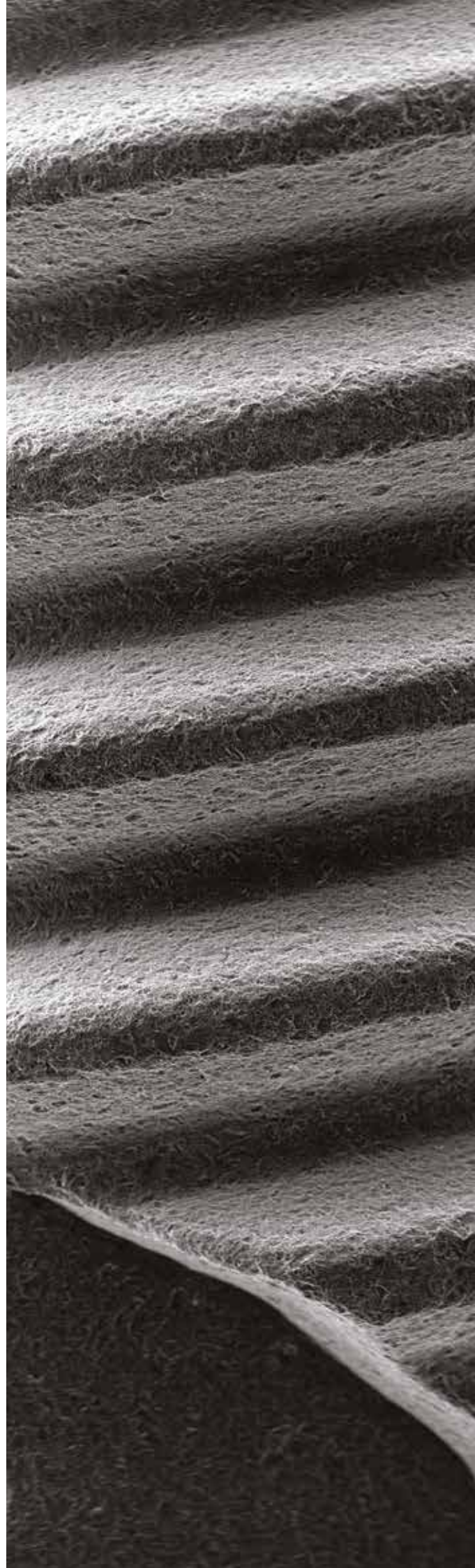

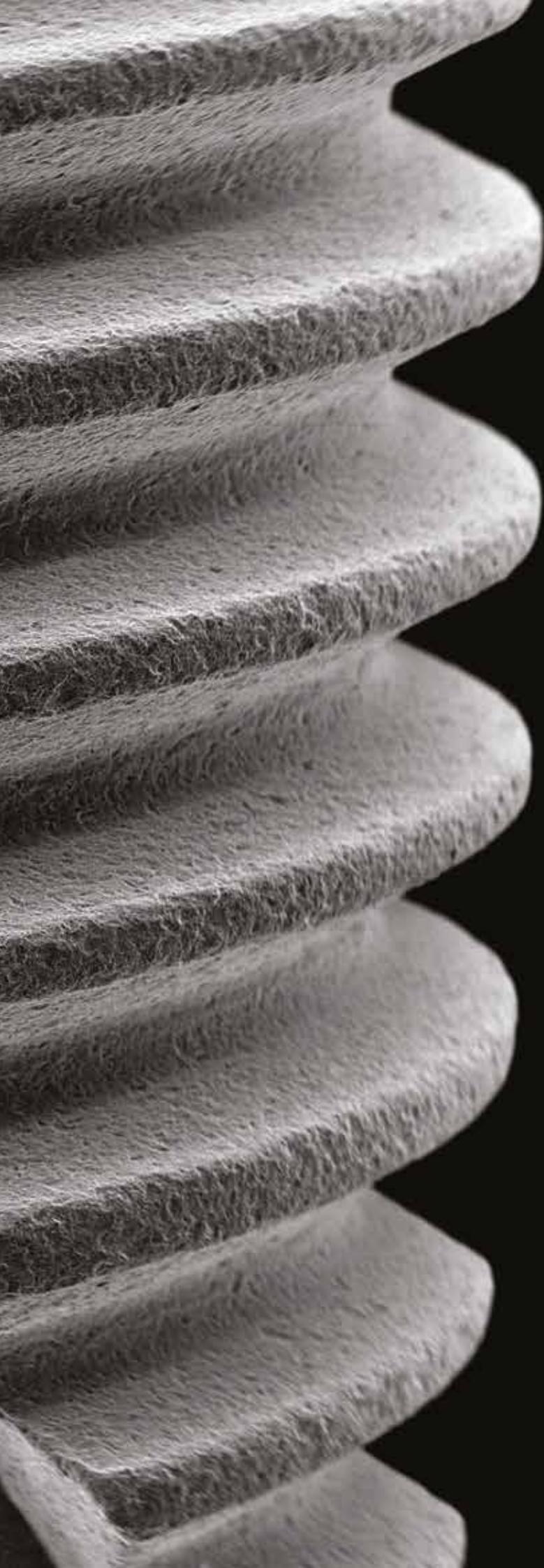

## **BONE LEVEL IMPLANTS**

---



UNIVERSAL SYSTEM FOR ALL TYPES OF BONES

FINE DOUBLE THREAD IMPLANT

∅	Implant thread	Connection	Platform	Hex	Thread
3.3	Fine double thread 0.6 mm	Internal hex	3.2 mm	2.1 mm	1/72

∅ 3.3

Heights (mm)	10   11.5   13   16
Material	Titanium Gr. 5



- 1. Platform switching
- 2a. 3 mm machined implant
- 2b. 1 mm machined neck
- 3. Cylindrical body
- 4. 60° double thread over the entire body implant with a pitch of 1,2 mm (0,6 mm/thread); each turn allows to go down of 1,2mm, speeding up the insertion phase.
- 5. 2 apical cuts helicoidal
- 6. Conical apex flat tip



**NHSI-HYHA**  
Hybrid with hyaluronic acid  
**165,00**

**NHSI-C**  
Neck Machined  
**135,00**



DRIVERS Material Surgical steel



Description	Code
h 25 mm	HDH21S



Description	Code
h 30 mm	HDH21L

LARGE DOUBLE THREAD IMPLANT

Ø	Implant thread	Connection	Platform	Hex	Thread
3.3	Large double thread 0.9 mm	Internal hex	3.2 mm	2.1 mm	1/72
<b>Ø 3.3</b>					
<b>Heights (mm)</b>		8   10   11.5   13   16			
<b>Material</b>		Titanium Gr. 5			



- 1. Platform switching
- 2. Implant with ogival design (bullet type)
- 3. Pronounced spires with cutting profile with 10° and 20°. Higher primary stability
- 4. 2 spiral counter-unload furrows
- 5. Tip with self-perforating auger design with grinding effect

	<b>SVB-C</b>
	Neck Machined
<b>135,00</b>	

**DRIVERS** Material Surgical steel



Description	Code
h 25 mm	HDH21S



Description	Code
h 30 mm	HDH21L

IMPLANT CONNECTION

rationalization of prosthetic components

Prosthetic components with **Friction Fit** connection have been developed for **SVB** and **NHSI** implant systems with **internal hex** connection. This connection ensures a **“cold fusion”** between implant and abutment if the retaining screw has

been tightened at 30 Ncm. It eliminates micro movements and reduces bacterial infiltration between implant and abutment.

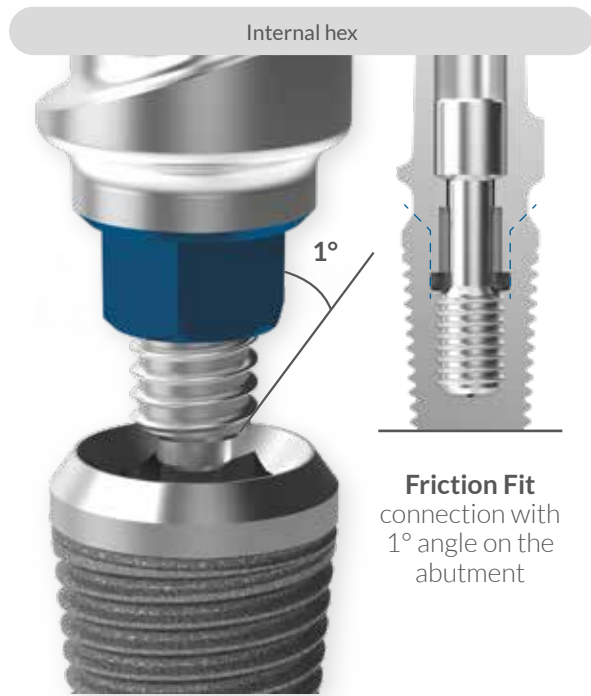

MANAGEMENT OF SOFT TISSUES

The following configurations are available for improved soft tissue management.

Straight profile



S profile



Concave profile





description | €

description | €

**SURGICAL SCREWS**

provided with the implant, available as spare parts | Material TI-6Al-4V

Ø 3.5 mm  
thread 1/72

15.00 €



S1BNCS

Ø 5.2 mm  
thread 1/72

15.00 €



S1BNCSL

**PROSTHETIC SCREWS**

Maximum screwing torque 30 Ncm | Material TI-6Al-4V

For abutments  
thread 1/72

15.00 €



S1BRS1

For comp MUA  
thread 1/72

15.00 €



S1BRS2

Long for  
transfer  
thread 1/72

15.00 €



S1BDTRS

Prosthetic  
screws torx

15.00 €



S1BRS1T6

**HEALING SCREWS**

Material TI-6Al-4V

Ø 3.5 mm

25.00 €



S1BN35 [xx] HC

Code	h (mm)
S1BN3530HC	3
S1BN3545HC	4.5
S1BN3560HC	6

With flared  
profile  
Ø 3.5 mm

25.00 €



S1BN35 [xx] HCC

Code	h (mm)
S1BN3510HCC	1
S1BN3530HCC	3
S1BN3545HCC	4.5
S1BN3560HCC	6

**ANALOG**

Material TI-6Al-4V

Analog

21.00 €



S1BNIA

Short analog  
for guided  
surgery

21.00 €



S1BNIAS

Digital  
analog

21.00 €



S1BNDIA

description | €

description | €

**DIGITAL SCAN ABUTMENT**

S1BRS1 screw included | Material TI-6Al-4V

55.00 €



S1BNSA

**INDIRECT IMPRESSION TRANSFER**

S1BRS1 screw included | Material TI-6Al-4V

Ø 3.5 mm  
Indirect  
transfer cap  
included

65.00 €



S1BN135ITC

Indirect  
transfer cap

20.00 €



ITC

Multifunction  
abutment  
Ø 3.5 mm

55.00 €



S1BN1A35

Multifunction  
abutment  
Ø 3.5 mm  
with flared  
profile

65.00 €



S1BN1M35C

**DIRECT IMPRESSION TRANSFER**

\*S1BDTRS screw included | Material TI-6Al-4V

Ø 3.5 mm

35.00 €



S1BN1M35L \*

Multifunction  
abutment  
Ø 3.5 mm

55.00 €



S1BN1A35L \*

Multifunction  
abutment  
Ø 3.2 mm

55.00 €



S1BN1M35L \*

3-components  
for disparallel  
systems  
Ø 5 mm

45.00 €

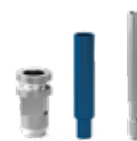

S1BN1M35L \*

description | €

description | €

TEMPORARY STRAIGHT ABUTMENTS

S1BRS1 screw included

PEEK  
Ø 3.5 mm

55.00 €



S1BN135PP

Anti rotation  
TI-6Al-4V  
Ø 3.5 mm

45.00 €



S1BN135P

Rotating  
TI-6Al-4V  
Ø 3.5 mm

45.00 €



S1BN135PR

DEFINITIVE STRAIGHT ABUTMENTS | ANATOMIC

S1BRS1 screw included | Material TI-6Al-4V

Friction Fit  
Ø 3.5 mm

65.00 €



S1BN135FF

Anatomic  
without  
Friction Fit  
Ø 4 mm

55.00 €



S1BN1 [x] 40

Code	h (mm)
S1BN1140	1
S1BN1340	3

Anatomic with  
Friction Fit  
Ø 4 mm

65.00 €



S1BN1 [x] 40F

Code	h (mm)
S1BN1140F	1
S1BN1340F	3

Abutments  
for welded  
technique

55.00 €



S1BN1TS

description | €

description | €

T-BASE

\*S1BRS1 screw included | \*\*S1BRS1 and S1BRS1T6 screw included | Material Ti-6Al-4V

IMPLANT LIBRARIES AVAILABLE ON THE SITE <https://it.ires.dental/media-kit/>

Friction Fit  
with emergence  
profile  
Ø 3.5 mm

65.00 €



S1BN135F\*

Rotating  
with emergence  
profile  
Ø 3.5 mm

55.00 €



S1BN135R\*

Friction Fit  
without  
emergence  
profile  
Ø 3.5 mm

65.00 €



S1BN135FS\*

Rotating  
without  
emergence  
profile  
Ø 3.5 mm

55.00 €



S1BN135RS\*

Not rotating  
Ø 3.7 mm  
Cuff 0.8 mm  
Shoulder  
0.4 mm

75.00 €



S1BN11DCTB\*\*

Not rotating  
Ø 3.7 mm  
Cuff 1.8 mm  
Shoulder  
0.4 mm

75.00 €



S1BN12DCTB\*\*

Not rotating  
Ø 3.7 mm  
Cuff 2.8 mm  
Shoulder  
0.4 mm

75.00 €



S1BN14DCTB\*\*

Not rotating  
Ø 4.5 mm  
Cuff 1.8 mm  
Shoulder  
0.8 mm

75.00 €



S1BN12DCTB50\*\*

Not rotating  
Ø 4.5 mm  
Cuff 2.8 mm  
Shoulder  
0.8 mm

75.00 €



S1BN14DCTB50\*\*

Rotating  
Ø 3.7 mm  
Cuff 0.8 mm  
Shoulder  
0.4 mm

75.00 €



S1BN11DCTBR\*\*

Rotating  
Ø 3.7 mm  
Cuff 1.8 mm  
Shoulder  
0.4 mm

75.00 €



S1BN12DCTBR\*\*

Rotating  
Ø 3.7 mm  
Cuff 2.8 mm  
Shoulder  
0.4 mm

75.00 €



S1BN14DCTBR\*\*

description | €

description | €

Rotating  
Ø 4.5 mm  
Cuff 1.8 mm  
Shoulder  
0.8 mm



S1BN12DCTBR50\*\*

75.00 €

Rotating  
Ø 4.5 mm  
Cuff 2.8 mm  
Shoulder  
0.8 mm



S1BN14DCTBR50\*\*

75.00 €

Not rotating  
Cerec shape



S1BN1DTBC

65.00 €

Rotating  
Cerec shape



S1BN1DTBCR

65.00 €

**ANATOMIC DEFINITIVE ANGLED ABUTMENTS**

S1BRS2 screw included | Material TI-6Al-4V

Without Friction Fit  
15°  
Ø 4 mm



S1BN2 [x] 1540

65.00 €

Code	h (mm)
S1BN211540	1
S1BN231540	3

Without Friction Fit  
25°  
Ø 4 mm



S1BN2 [x] 2540

65.00 €

Code	h (mm)
S1BN212540	1
S1BN232540	3

Friction Fit  
15°  
Ø 4 mm



S1BN2 [x] 1540F

75.00 €

Code	h (mm)
S1BN211540F	1
S1BN231540F	3

Friction Fit  
25°  
Ø 4 mm



S1BN2 [x] 2540F

75.00 €

Code	h (mm)
S1BN212540F	1
S1BN232540F	3

**CASTABLE ABUTMENTS**

S1BRS1 screw included

Gold base  
POM-C /  
AU&PGM  
Ø 4.5 mm



S1BN3GA35\*

110.00 €

POM-C  
Ø 3.5 mm

29.00 €



S1BN3PC35

Rotating  
POM-C  
Ø 3.5 mm

29.00 €



S1BN3PCR35

Titanium base  
TI-6Al-4V

75.00 €



S1BN3PTC45

\*Gold alloy AU60% PD15% PT24,9% IR0,1% AU e PGM100%. Melting range C° 1350/1460 Tensile modulus GPa 110. Elastic limit MPa 450-720. Stretching %18-12. Breaking load MPa 580-810. Vickers hardness HV5/30 105-205-230.

description | €

description | €

**STRAIGHT MUA ABUTMENTS**

Mounter included | Material TI-6Al-4V

Ø 5 mm

55.00 €



S1BN4 [X]

Code	h (mm)
S1BN41	1
S1BN42	2
S1BN43	3
S1BN44	4
S1BN45	5
S1BN46	6

For MUA prosthetic components visit page 66  
Tighten with HDH20 driver (page 80)

**ANGLED MUA ABUTMENTS**

Mounter and S1BRS2 screw included | Material TI-6Al-4V

18°  
Ø 5 mm  
h 0/2 mm

85.00 €

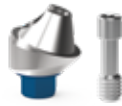

S1BN518

30°  
Ø 5 mm  
h 0/2 mm

85.00 €



S1BN532

For MUA prosthetic components visit page 66

**BALL ABUTMENTS**

Cap e Calt included | TIN Treatment on the gold part | Material TI-6Al-4V

Ø 4 mm

45.00 €



S1BN6 [X]

Code	h (mm)
S1BN61	1
S1BN62	2
S1BN63	3
S1BN64	4
S1BN65	5

Containment  
ring



CAH

Nylon  
containment  
cap



CALT

Tighten with MDS (page 81) or MDL (page 81) screwdriver

**CONTAINMENT RING and CONTAINMENT CAP**

Available as replacement

Material TI-6Al-4V

Containment  
ring

15.00 €



CAH

Nylon  
containment  
cap

7.50 €



CALT

description | €

description | €

**iRETOR** (Ring and cap not included)

TIN Treatment on the gold part

TIN  
95.<sup>00</sup> €

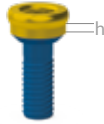

S1BN8 [xx]

Code	h (mm)
S1BN80	0
S1BN81	1
S1BN825	2.5
S1BN835	3.5
S1BN845	4.5
S1BN865	6.5

Tighten with 8393 screwdriver (page 81)

**iRETOR ACCESSORIES**

Analog for  
iRETOR®  
female coupling  
Q.ty: 4  
Al

50.<sup>00</sup> €



8530

Indirect  
impression  
tear pin for  
iRETOR®  
Q.ty: 4  
Al

50.<sup>00</sup> €



8505

Set of cups and  
rings for parallel  
implants  
Q.ty: 1  
Ti | Nylon

27.<sup>50</sup> €



S1B85

Resistant  
male  
(1.8 kg)  
Q.ty: 4

30.<sup>00</sup> €



S1B8518

Light  
male  
(1.2 kg)  
Q.ty: 4

30.<sup>00</sup> €



S1B8512

Extralight  
male  
(0.6 kg)  
Q.ty: 4

30.<sup>00</sup> €



S1B8506

INTERNAL HEX da 2.5 mm | Bone level

∅ 3.7 - 4.1 - 4.7 - 5.2

SHAPEONE

EXCELLENT PRIMARY STABILITY ALSO IN BONE D4

FINE TRIPLE THREAD IMPLANT

∅	Implant thread	Connection	Platform	Hex	Thread
3.75 - 4.1 - 4.7	Triple thread 0.9 mm	Internal hex	3.5 mm	2.5 mm	1/72

	∅ 3.75	∅ 4.1 e ∅ 4.7
Heights (mm)	8   10   11.5   13   16	6.5   8   10   11.5   13   16
Material	Titanium Gr. 5	Titanium Gr. 4



1. Platform switching
- 2a. 3 mm machined implant
- 2b. 1 mm machined neck
3. Self tapping conical body
4. 60° triple thread over the entire body implant with a pitch of 1,8 mm
5. 3 apical aggressive cuts provide a better primary stability and centering of the implant and the possibility to change direction during its insertion
6. Apex aggressive but rounded to protect the Schneider's membrane



**S1B-HYHA**

Hybrid with hyaluronic acid

**165,00**

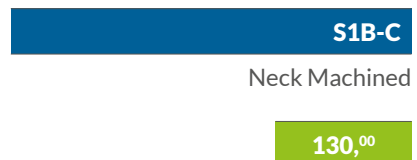

**S1B-C**

Neck Machined

**130,00**



DRIVERS

Material Surgical steel



Description	Code
h 25 mm	HDH25S



Description	Code
h 30 mm	HDH25L





UNIVERSAL SYSTEM FOR ALL TYPES OF BONES

FINE DOUBLE THREAD IMPLANT

∅	Implant thread	Connection	Platform	Hex	Thread
3.75 - 4.1 - 4.7 - 5.2	Fine double thread 0.6 mm	Internal hex	3.5 mm	2.5 mm	1/72
	<b>∅ 3.75</b>	<b>∅ 4.1 e ∅ 4.7</b>	<b>∅ 5.2</b>		
<b>Heights (mm)</b>	8   10   11.5   13   16	6.5   8   10   11.5   13   16	6.5   8   10   11.5   13		
<b>Material</b>	Titanium Gr. 5	Titanium Gr. 4	Titanium Gr. 4		



- 1. Platform switching
- 2a. 3 mm machined implant
- 2b. 1 mm machined neck
- 3. Cylindrical body
- 4. 60° double thread over the entire body implant with a pitch of 1,2 mm (0,6 mm/thread); each turn allows to go down of 1,2mm, speeding up the insertion phase
- 5. 2 apical cuts helicoidal
- 6. Conical apex flat tip



**NHSI-HYHA**  
Hybrid with hyaluronic acid  
**165,00**

**NHSI-C**  
Neck Machined  
**130,00**



DRIVERS Material Surgical steel



Description	Code
h 25 mm	HDH25S



Description	Code
h 30 mm	HDH25L

LARGE DOUBLE THREAD IMPLANT

∅	Implant thread	Connection	Platform	Hex	Thread
3.75 - 4.1 - 4.7 - 5.2	Large double thread 0.9 mm	Internal hex	3.5 mm	2.5 mm	1/72
<b>∅ 3.75</b>		<b>∅ 4.1 e ∅ 4.7</b>		<b>∅ 5.2</b>	
<b>Heights (mm)</b>	8   10   11.5   13   16	6.5   8   10   11.5   13   16	6.5   8   10   11.5   13		
<b>Material</b>	Titanium Gr. 5	Titanium Gr. 4		Titanium Gr. 4	

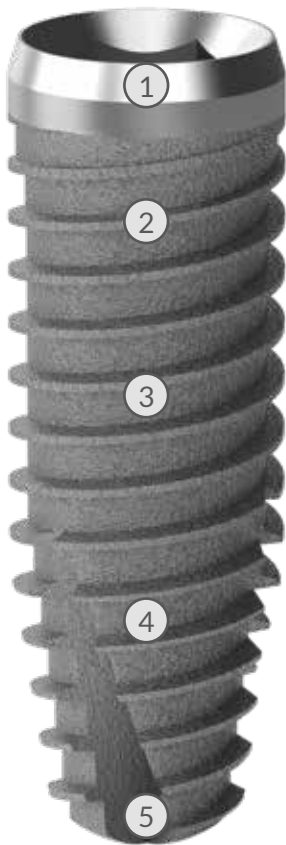

- 1. Platform switching
- 2. Implant with ogival design (bullet type)
- 3. Pronounced spires with cutting profile with 10° and 20°. Higher primary stability
- 4. 2 spiral counter-unload furrows
- 5. Tip with self-perforating auger design with grinding effect

SVB-C

Neck Machined

135,00

**DRIVERS** Material Surgical steel

	Description	Code		Description	Code
	h 25 mm	HDH25S		h 30 mm	HDH25L

IMPLANT CONNECTION

rationalization of prosthetic components

Prosthetic components with **Friction Fit** connection have been developed for **S1B**, **SVB** and **NHSI** implant systems with **internal hex** connection. This connection ensures a **“cold fusion”** between implant and abutment if the retaining

screw has been tightened at 30 Ncm. It eliminates micro movements and reduces bacterial infiltration between implant and abutment.

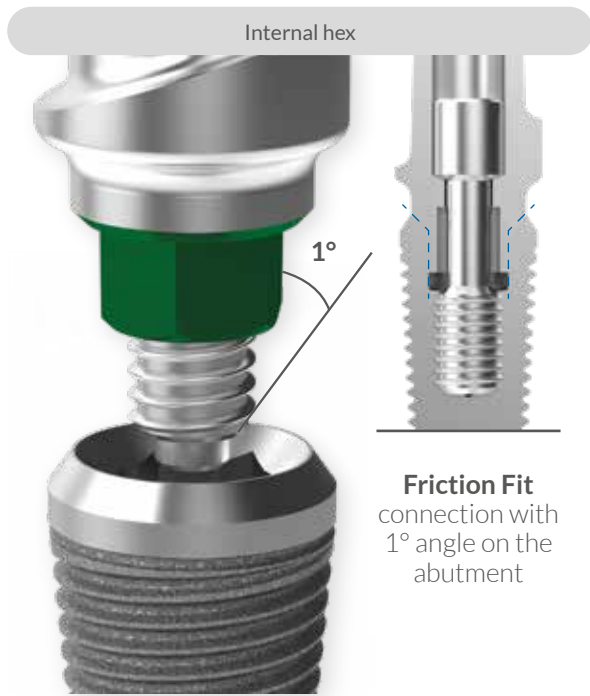

MANAGEMENT OF SOFT TISSUES

The following configurations are available for improved soft tissue management.

Straight profile



S profile



Concave profile



45° profile



description | €

description | €

**SURGICAL SCREWS**

provided with the implant, available as spare parts | Material Ti-6Al-4V

Ø 3.5 mm  
thread 1/72

15.00 €



S1BCS

Ø 5.2 mm  
thread 1/72

15.00 €



S1BCSL

**PROSTHETIC SCREWS**

Maximum screwing torque 30 Ncm | Material Ti-6Al-4V

For abutment  
thread 1/72

15.00 €



S1BRS1

For MUA  
thread 1/72

15.00 €



S1BRS2

Long for  
transfer  
thread 1/72

15.00 €



S1BDTRS

Torx screw  
for digital

15.00 €



S1BRS1T6

**HEALING SCREWS**

Material Ti-6Al-4V

Ø 3.5 mm

25.00 €



S1B35 [x] HC

Code	h (mm)
S1B3530HC	3
S1B3545HC	4.5
S1B3560HC	6

Ø 5 mm

25.00 €



S1B50 [x] HC

Code	h (mm)
S1B5030HC	3
S1B5045HC	4.5
S1B5060HC	6

Ø 6 mm

30.00 €



S1B60 [x] HC

Code	h (mm)
S1B6030HC	3
S1B6045HC	4.5

description | €

description | €

**HEALING SCREWS with FLARED PROFILE**

Material TI-6Al-4V

Ø 3.5 mm

25.00 €



S1B35 [xx] HCC

Code	h (mm)
S1B3530HCC	3
S1B3545HCC	4.5
S1B3560HCC	6

Ø 5 mm

25.00 €



S1B50 [xx] HCC

Code	h (mm)
S1B5030HCC	3
S1B5045HCC	4.5
S1B5060HCC	6

Ø 6 mm

30.00 €



S1B60 [xx] HCC

Code	h (mm)
S1B6030HCC	3
S1B6045HCC	4.5

**ANALOG**

Material TI-6Al-4V

Analog

21.00 €



S1BIA

Short  
for guided  
surgery

21.00 €



S1BIAS

Digital  
analog

21.00 €



S1BDIA

**DIGITAL SCAN ABUTMENT**

S1BRS1 screw included | Material TI-6Al-4V

55.00 €



S1BSA

description | €





description | €

**INDIRECT IMPRESSION TRANSFER** (continue) \*ITC and S1BRS1 screw included | \*\*S1BRS1 screw included | Material TI-6Al-4V

<p>Ø 3.5 mm <b>65.00 €</b></p>	 <p>S1B135ITC *</p>	<p>Indirect transfer cap <b>20.00 €</b></p>	 <p>ITC</p>
<p>Ø 5 mm <b>65.00 €</b></p>	 <p>S1B150ITC *</p>	<p>Multifunction abutment Ø 5 mm <b>55.00 €</b></p>	 <p>S1B1A50 **</p>
<p>Multifunction abutment Ø 5 mm with flared profile <b>65.00 €</b></p>	 <p>S1B1M50C **</p>		

**DIRECT IMPRESSION TRANSFER**

\*S1BDTRS screw included | Material TI-6Al-4V

<p>Ø 3.5 mm <b>35.00 €</b></p>	 <p>S1BDT35 *</p>	<p>Ø 5 mm <b>35.00 €</b></p>	 <p>S1BDT50 *</p>
<p>3-components for disparallel systems Ø 5 mm <b>45.00 €</b></p>	 <p>S1BDT503</p>	<p>Multifunction abutment Ø 5 mm <b>55.00 €</b></p>	 <p>S1B1A50L *</p>
<p>Multifunction abutment Ø 5 mm with flared profile <b>65.00 €</b></p>	 <p>S1B1M50CL *</p>		

description | €

description | €

**TEMPORARY STRAIGHT ABUTMENTS**

S1BRS1 screw included

Rotating  
TI-6Al-4V  
Ø 4 mm

45.00 €



S1B140PR

Anti rotation  
TI-6Al-4V  
Ø 4 mm

45.00 €



S1B140P

PEEK  
Ø 4 mm

55.00 €



S1B140PP

**DEFINITIVE STRAIGHT ABUTMENTS | ANATOMIC**

S1BRS1 screw included | Material TI-6Al-4V

Friction Fit  
Ø 3.5 mm

65.00 €



S1B135F

Friction Fit  
Ø 5 mm

65.00 €



S1B150F

Friction Fit  
without  
emergence  
profile  
Ø 4.5 mm

65.00 €



S1B145FS

Friction Fit  
without  
emergence  
profile  
Ø 5.5 mm

65.00 €



S1B155FS

Anatomic  
without  
Friction Fit  
Ø 4.5 mm

55.00 €



S1B1 [\*] 45

Code	h (mm)
S1B1145	1
S1B1345	3

Anatomic with  
Friction Fit  
Ø 4.5 mm

65.00 €



S1B1 [\*] 45F

Code	h (mm)
S1B1145F	1
S1B1345F	3

Abutment  
for welded  
technique

55.00 €



S1B1TS

description | €

description | €

T-BASE

\*S1BRS1 screw included | \*\*S1BRS1 and S1BRS1T6 screw included | Material Ti-6Al-4V

IMPLANT LIBRARIES AVAILABLE ON THE SITE <https://it.ires.dental/media-kit/>

Friction Fit  
with emergence  
profile  
Ø 4.5 mm

65.00 €



S1B140F\*

Rotating  
with emergence  
profile  
Ø 4.5 mm

55.00 €



S1B140R\*

Friction Fit  
without  
emergence  
profile  
Ø 4.5 mm

65.00 €



S1B140FS\*

Rotating  
without  
emergence  
profile  
Ø 4.5 mm

55.00 €



S1B140RS\*

Not rotating  
Ø 3.4 mm  
Cuff 0 mm  
Shoulder  
0.4 mm

75.00 €



S1B00DCTB\*\*

Not rotating  
Ø 3.7 mm  
Cuff 0.5 mm  
Shoulder  
0.4 mm

75.00 €



S1B11DCTB\*\*

Not rotating  
Ø 3.7 mm  
Cuff 1.8 mm  
Shoulder  
0.4 mm

75.00 €



S1B12DCTB\*\*

Not rotating  
Ø 5.7 mm  
Cuff 1.8 mm  
Shoulder  
1.2 mm

75.00 €



S1B14DCTB\*\*

Not rotating  
Ø 4.5 mm  
Cuff 1.8 mm  
Shoulder  
0.8 mm

75.00 €



S1B12DCTB50\*\*

Not rotating  
Ø 5.7 mm  
Cuff 2.8 mm  
Shoulder  
1.2 mm

75.00 €



S1B14DCTB50\*\*

Rotating  
Ø 3.4 mm  
Cuff 0 mm  
Shoulder  
0.4 mm

75.00 €



S1B00DCTBR\*\*

Rotating  
Ø 3.7 mm  
Cuff 0.5 mm  
Shoulder  
0.4 mm

75.00 €



S1B11DCTBR\*\*



description | €

description | €

Rotating  
Ø 3.7 mm  
Cuff 1.8 mm  
Shoulder  
0.4 mm



S1B12DCTBR\*\*

75.00 €

Rotating  
Ø 5.7 mm  
Cuff 1.8 mm  
Shoulder  
1.2 mm



S1B14DCTBR\*\*

75.00 €

Rotating  
Ø 4.5 mm  
Cuff 1.8 mm  
Shoulder  
0.8 mm



S1B12DCTBR50\*\*

75.00 €

Rotating  
Ø 5.7 mm  
Cuff 2.8 mm  
Shoulder  
1.2 mm



S1B14DCTBR50\*\*

75.00 €

Not rotating  
Cerec shape



S1B1DTBC

65.00 €

Rotating  
Cerec shape



S1B1DTBCR

65.00 €

**ANGLED ABUTMENTS**

S1BRS2 screw included | Material TI-6Al-4V

Friction Fit  
20° Ø 4.5 mm

75.00 €



S1B250F

Friction Fit  
without  
emergence  
profile  
20° Ø 4.5 mm

75.00 €



S1B245FS

**ANATOMIC DEFINITIVE ANGLED ABUTMENTS**

S1BRS2 screw included | Material TI-6Al-4V

Without  
Friction Fit  
15°  
Ø 4.5 mm

65.00 €

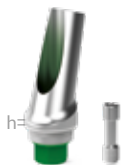

S1B2 [x] 1545

Code	h (mm)
S1B211545	1
S1B231545	3

Without  
Friction Fit  
25°  
Ø 4.5 mm

65.00 €



S1B2 [x] 2545

Code	h (mm)
S1B212545	1
S1B232545	3

Friction Fit  
15°  
Ø 4.5 mm

75.00 €



S1B2 [x] 1545F

Code	h (mm)
S1B211545F	1
S1B231545F	3

Friction Fit  
25°  
Ø 4.5 mm

75.00 €



S1B2 [x] 2545F

Code	h (mm)
S1B212545F	1
S1B232545F	3

description | €

description | €

**CASTABLE ABUTMENTS**

S1BRS1 screw included

Gold base  
POM-C /  
AU&PGM  
Ø 5 mm

110.00 €



S1B3GA50\*

POM-C  
Ø 4.5 mm

29.00 €



S1B3PC45

Rotating  
POM-C  
Ø 4.5 mm

29.00 €



S1B3PCR45

Titanium base  
TI-6Al-4V

75.00 €



S1B3PTC45

\*Gold alloy AU60% PD15% PT24,9% IR0,1% AU e PGM100%. Melting range C° 1350/1460 Tensile modulus GPa 110. Elastic limit MPa 450-720. Stretching %18-12. Breaking load MPa 580-810. Vickers hardness HV5/30 105-205-230.

**STRAIGHT MUA ABUTMENTS**

Mounter included | Material TI-6Al-4V

Ø 5 mm

55.00 €



S1B4 [X]

Code	h (mm)
S1B41	1
S1B42	2
S1B43	3
S1B44	4
S1B45	5
S1B46	6

For MUA prosthetic components visit page 66  
Tighten with HDH20 driver (page 80)

**ANGLED MUA ABUTMENTS**

Mounter and S1BRS2 screw included | Material TI-6Al-4V

18°  
Ø 5 mm  
h 0/2 mm

85.00 €



S1B518

30°  
Ø 5 mm

85.00 €



S1B53 [X]

Code	h (mm)
S1B532	0/2
S1B534	2/4

For MUA prosthetic components visit page 66

**BALL ABUTMENTS**

Cap e Calt included | TIN Treatment on the gold part | Material TI-6Al-4V

Ø 4 mm

45.00 €



S1B6 [X]

Code	h (mm)
S1B61	1
S1B62	2
S1B63	3
S1B64	4
S1B65	5

Containment  
ring



CAH

Nylon  
containment  
cap



CALT

Tighten with MDS (page 81) or MDL (page 81) screwdriver

description | €

description | €

**CONTAINMENT RING and CONTAINMENT CAP**

Available as replacement

Material TI-6Al-4V

Containment ring

15.00 €



CAH

Nylon containment cap

7.50 €



CALT

**iRETOR** (Ring and cap not included)

TIN Treatment on the gold part

TIN

95.00 €

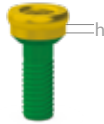

S1B8 [X\*]

Code	h (mm)
S1B80	0
S1B81	1
S1B825	2.5
S1B835	3.5
S1B845	4.5
S1B865	6.5

Tighten with 8393 screwdriver (page 81)

**iRETOR ACCESSORIES**

Analog for iRETOR® female coupling  
Q.ty: 4  
Al

50.00 €



8530

Indirect impression tear pin for iRETOR®  
Q.ty: 4  
Al

50.00 €



8505

Set of cups and rings for parallel implants  
Q.ty: 1  
Ti | Nylon

27.50 €



S1B85

Resistant male (1.8 kg)  
Q.ty: 4

30.00 €



S1B8518

Light male (1.2 kg)  
Q.ty: 4

30.00 €



S1B8512

Extralight male (0.6 kg)  
Q.ty: 4

30.00 €



S1B8506



UNIVERSAL SYSTEM FOR ALL TYPES OF BONES

FINE DOUBLE THREAD IMPLANT

Ø	Implant thread	Connection	Platform	Hex	Thread
3.3	Fine double thread 0.6 mm	External hex	3.5 mm	2.4 mm	1.6 mm

Ø 3.3	
Heights (mm)	10   11.5   13   16
Material	Titanium Gr. 5



1a. 3 mm machined implant

1b. 1 mm machined neck

2. Cylindrical body

3. 60° double thread over the entire body implant with a pitch of 1,2 mm (0,6 mm/thread); each turn allows to go down of 1,2mm, speeding up the insertion phase

4. 2 apical cuts helicoidal

5. Conical apex flat tip



**NHSE-HYHA**  
Hybrid with hyaluronic acid  
**165,00**

**NHSE-C**  
Neck Machined  
**135,00**



DRIVERS Material Surgical steel



Description	Code
h 25 mm	HDH24S



Description	Code
h 30 mm	HDH24L

IMPLANT CONNECTION

rationalization of prosthetic components

A “flat to flat” connection for external hex is especially suitable for **NHSE** implant systems iRES® offers different implant products to cover a wide range of treatment options and fulfill every surgical need.

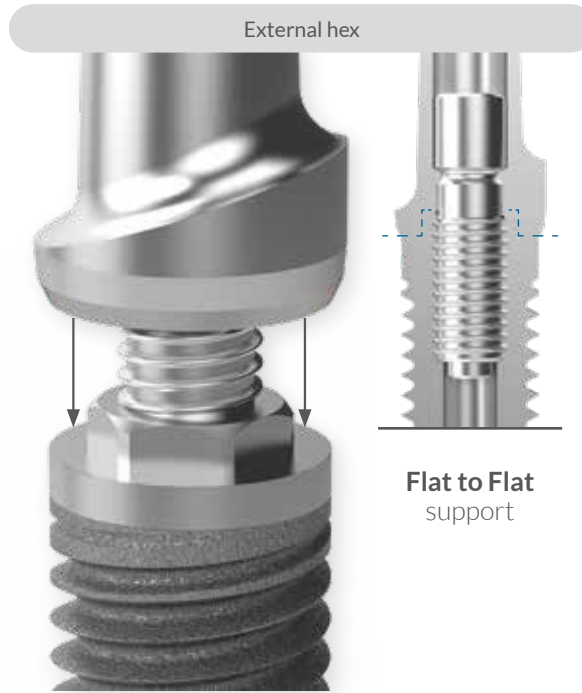

MANAGEMENT OF SOFT TISSUES

The following configurations are available for improved soft tissue management.

Straight profile



Slightly concave profile



description | €

description | €

**SURGICAL SCREWS**

provided with the implant, available as spare parts | Material TI-6Al-4V

 Ø 3.5 mm  
thread 1.6 mm

**15.00 €**

S1EHNCS

**PROSTHETIC SCREWS**

Maximum screwing torque 25 Ncm | Material TI-6Al-4V

 For abutment  
thread 1.6 mm

**15.00 €**

S1EHNRS1

 For abutment  
thread 1.6 mm

**15.00 €**

S1EHNRS2

 Long for  
transfer  
thread 1.6 mm

**15.00 €**

S1EHNDTRS

 Torx screw  
for digital

**15.00 €**

S1EHNRS1T6

**HEALING SCREWS**

Material TI-6Al-4V

Ø 3.5 mm

**25.00 €**

Code	h (mm)
S1EHN3530HC	3
S1EHN3545HC	4.5
S1EHN3560HC	6

S1EHN35 [xx] HC

description | €

description | €

**ANALOG**

Material TI-6Al-4V

21.00 €



S1EHNIA

 Short  
for guided  
surgery

21.00 €



S1EHNIA

 Digital  
analog

21.00 €



S1EHNDIA

**DIGITAL SCAN ABUTMENT**

S1EHNRS1 screw included | Material TI-6Al-4V

55.00 €



S1EHNSA

**DIRECT IMPRESSION TRANSFER**

S1EHNDRS screw included | Material TI-6Al-4V

Ø 3.5 mm

35.00 €



S1EHNDT35

 Multifunction  
Ø 3.5 mm

65.00 €



S1EHN1A35L

**TEMPORARY STRAIGHT ABUTMENTS**

S1EHNRS1 screw included | Material TI-6Al-4V

 Anti rotation  
Ø 3.5 mm

45.00 €



S1EHN135P

 Rotating  
Ø 3.5 mm

45.00 €



S1EHN135PR

description | €

description | €

**DEFINITIVE STRAIGHT ABUTMENTS | ANATOMIC**

S1EHNRS1 screw included | Material TI-6Al-4V

**Multifunction  
Ø 3.5 mm**  
*colored internal  
prosthetic part*
**65.00 €**

**S1EHN1A35**
**Anti rotation  
Ø 4 mm**  
*colored internal  
prosthetic part*
**65.00 €**

**S1EHN140**
**Anatomic  
Ø 3.5 mm**  
*colored internal  
prosthetic part*
**65.00 €**

**S1EHN1 [x] 35**

Code	h (mm)
S1EHN1135	1
S1EHN1335	3

**Abutments  
for welded  
technique**  
*colored internal  
prosthetic part*
**55.00 €**

**S1EHN1TS**
**DIGITAL T-BASE**

S1EHNRS1 and S1EHNRS1T6 screw included | Material TI-6Al-4V

**Not rotating**
**70.00 €**

**S1EHN1DTB**
**Rotating**
**70.00 €**

**S1EHN1DTBR**
**STICKING BASES**

S1EHNRS1 screw included | Material TI-6Al-4V

**Anti rotation  
Ø 4 mm**  
*colored internal  
prosthetic part*
**65.00 €**

**S1EHN135**
**Rotating  
Ø 4 mm**  
*colored internal  
prosthetic part*
**55.00 €**

**S1EHN135R**



description | €

description | €

**ANATOMIC DEFINITIVE ANGLED ABUTMENTS**

S1EHNRS2 screw included | Material TI-6Al-4V

 Angled 15°  
 Ø 4 mm  
 colored internal  
 prosthetic part

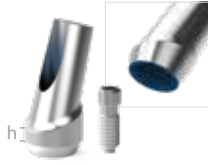
**75.00 €**

S1EHN2 [x] 1540

Code	h (mm)
S1EHN211540	1
S1EHN231540	3

 Angled 25°  
 Ø 4 mm  
 colored internal  
 prosthetic part

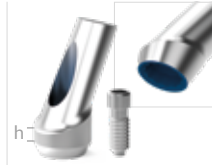
**75.00 €**

S1EHN2 [x] 2540

Code	h (mm)
S1EHN212540	1
S1EHN232540	3

**CASTABLE ABUTMENTS**

\*S1EHNRS1 screw included | Material POM-C

 Gold base  
 POM-C /  
 AU&PGM  
 Ø 3.5 mm

**110.00 €**

S1EHN3GA \*

Gold alloy AU60% PD15% PT24,9% IR0,1% AU e PGM100%. Melting range. C° 1350/1460 Tensile modulus GPa 110. Elastic limit MPa 450-720. Stretching%18-12. Breaking load MPa 580-810. Vickers hardness HV5/30 105-205-230.

 Gold base  
 rotante  
 POM-C /  
 AU&PGM  
 Ø 3.5 mm

**110.00 €**

S1EHN3GAR \*

Gold alloy AU60% PD15% PT24,9% IR0,1% AU e PGM100%. Melting range. C° 1350/1460 Tensile modulus GPa 110. Elastic limit MPa 450-720. Stretching%18-12. Breaking load MPa 580-810. Vickers hardness HV5/30 105-205-230.

Ø 3.5 mm

**29.00 €**

S1EHN3PC35 \*

 Rotating  
 Ø 3.5 mm

**29.00 €**

S1EHN3PCR35 \*

**STRAIGHT MUA ABUTMENTS**

Mounter included | Material TI-6Al-4V

Ø 3.5 mm

**55.00 €**

S1EHN4 [x]

Code	h (mm)
S1EHN41	1
S1EHN42	2
S1EHN43	3
S1EHN44	4
S1EHN45	5

For MUA prosthetic components visit page 66  
 Tighten with HDH20 driver (page 80)

description | €

description | €

**ANGLED MUA ABUTMENTS**

S1EHNRS2 screw included | Mounter included | Material TI-6Al-4V

18°  
h 0/2 mm  
Ø 3.5 mm  
*colored internal  
prosthetic part*



S1EHN518

**85.00 €**

30°  
h 0/2 mm  
Ø 3.5 mm  
*colored internal  
prosthetic part*



S1EHN532

**85.00 €**

For MUA prosthetic components visit page 66

**BALL ABUTMENTS**

cah e calt included | TIN Treatment on the gold part | Material TI-6Al-4V

Ø 3.5 mm  
**45.00 €**

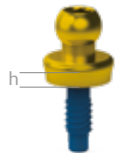

S1EHN6 [X]

Code	h (mm)
S1EHN61	1
S1EHN62	2
S1EHN63	3
S1EHN64	4

 Containment  
ring

CAH

 Nylon  
containment  
cap

CALT

Tighten with MDS (page 81) or MDL (page 81) screwdriver

**CONTAINMENT RING and CONTAINMENT CAP**

Available as replacement

Material TI-6Al-4V

Containment  
ring  
**15.00 €**



CAH

 Nylon  
containment  
cap

**7.50 €**

CALT

description | €

description | €

**iRETOR** (Ring and cap not included)

TIN Treatment on the gold part

**TIN  
95.00 €**

S1EHN8 [X]

Code	h (mm)
S1EHN80	0
S1EHN81	1
S1EEHN825	2.5
S1EHN835	3.5
S1EHN845	4.5
S1EHN865	6.5

Tighten with 8393 screwdriver (page 81)

**iRETOR ACCESSORIES**

 Analog for  
iRETOR®  
female coupling  
Q.ty: 4  
Al

**50.00 €**

8530

 Indirect  
impression  
tear pin for  
iRETOR®  
Q.ty: 4  
Al

**50.00 €**

8505

 Set of cups and  
rings for parallel  
implants  
Q.ty: 1  
Ti | Nylon

**27.50 €**

S1B85

 Resistant  
male  
(1.8 kg)  
Q.ty: 4

**30.00 €**

S1B8518

 Light  
male  
(1.2 kg)  
Q.ty: 4

**30.00 €**

S1B8512

 Extralight  
male  
(0.6 kg)  
Q.ty: 4

**30.00 €**

S1B8506



UNIVERSAL SYSTEM FOR ALL TYPES OF BONES

FINE DOUBLE THREAD IMPLANT

∅	Implant thread	Connection	Platform	Hex	Thread
3.75 - 4.1 - 4.7 - 5.2	Fine double thread 0.6 mm	External hex	4.1 mm	2.7 mm	2 mm
<b>∅ 3.75</b>		<b>∅ 4.1 - ∅ 4.7</b>		<b>∅ 5.2</b>	
<b>Heights (mm)</b>	6.5   8   10   11.5   13   16	6.5   8   10   11.5   13   16	6.5   8   10   11.5   13		
<b>Material</b>	Titanium Gr. 5	Titanium Gr. 4		Titanium Gr. 4	



1a. 3 mm machined implant



1b. 1 mm machined neck

2. Cylindrical body

3. 60° double thread over the entire body implant with a pitch of 1,2 mm (0,6 mm/thread); each turn allows to go down of 1,2mm, speeding up the insertion phase

4. 2 apical cuts helicoidal

5. Conical apex flat tip



**NHSE-HYHA**  
Hybrid with hyaluronic acid  
**165,00**

**NHSE-C**  
Neck Machined  
**135,00**



DRIVERS Material Surgical steel



Description	Code
h 25 mm	HDH27S



Description	Code
h 30 mm	HDH27L

IMPLANT CONNECTION

rationalization of prosthetic components

A “flat to flat” connection for external hex is especially suitable for **NHSE** implant systems iRES® offers different implant products to cover a wide range of treatment options and fulfill every surgical need.

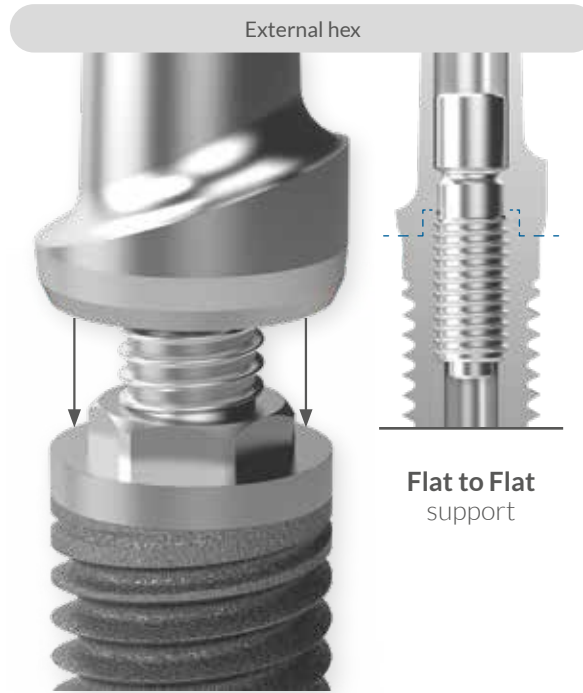

MANAGEMENT OF SOFT TISSUES

The following configurations are available for improved soft tissue management.

Slightly concave profile



description | €

description | €

**SURGICAL SCREWS**

provided with the implant, available as spare parts | Material TI-6Al-4V

 Ø 4.1 mm  
thread 2 mm

**15.00 €**

S1EHNCS

**PROSTHETIC SCREWS**

Maximum screwing torque 30 Ncm

Material TI-6Al-4V

 For abutment  
thread 2 mm

**15.00 €**

S1EHR1

 For abutment  
thread 2 mm

**15.00 €**

S1EHR2

 Long for  
transfer  
thread 2 mm

**15.00 €**

S1EHDTRS

 Torx screw  
for digital

**15.00 €**

S1EHR1T6

**HEALING SCREWS**

Material TI-6Al-4V

Ø 4.1 mm

**25.00 €**

S1EH41 [xx] HC

Code	h (mm)
S1EH4130HC	3
S1EH4145HC	5
S1EH4160HC	6

Ø 5 mm

**25.00 €**

S1EH50 [xx] HC

Code	h (mm)
S1EH5030HC	3
S1EH5045HC	5
S1EH5060HC	6

description | €

description | €

**ANALOG**

Material TI-6Al-4V

21.00 €



S1EHIA

Short  
for guided  
surgery

21.00 €



S1EHIAS

Digital  
analog

21.00 €



S1EHDIA

**DIGITAL SCAN ABUTMENT**

S1EHS1 screw included | Material TI-6Al-4V

55.00 €



S1EHS1

**DIRECT IMPRESSION TRANSFER**

\*\*S1EHDTRS screw included | Material TI-6Al-4V

Ø 4.1 mm

35.00 €



S1EHD41 \*\*

Ø 5 mm

35.00 €



S1EHD50 \*\*

Multifunction

55.00 €



S1EH1A50L \*\*

description | €

description | €

**TEMPORARY STRAIGHT ABUTMENTS**

S1EHR51 screw included | Material TI-6Al-4V

 Anti rotation  
 Ø 4.1 mm

**45.00 €**

S1EH141P

 Rotating  
 Ø 4.1 mm

**45.00 €**

S1EH141PR

**DEFINITIVE STRAIGHT ABUTMENTS | ANATOMIC**

S1EHR51 screw included | Material TI-6Al-4V

 Multifunction  
 Ø 5 mm

*colored internal  
 prosthetic part*
**65.00 €**

S1EH1A50

 Anti rotation  
 Ø 5 mm

*colored internal  
 prosthetic part*
**65.00 €**

S1EH150

 Anatomic  
 Ø 4.1 mm

*colored internal  
 prosthetic part*
**65.00 €**

S1EH1 [\*] 41

 Abutments  
 for welded  
 technique

*colored internal  
 prosthetic part*
**55.00 €**

S1EH1TS

**DIGITAL T-BASE**

S1EHR51 and S1EHR51T6 screw included | Material TI-6Al-4V

Not rotating

**70.00 €**

S1EH1DTB

Rotating

**70.00 €**

S1EH1DTBR

**STICKING BASES**

S1EHR51 screw included | Material TI-6Al-4V

 Anti rotation  
 Ø 4.1 mm

*colored internal  
 prosthetic part*
**65.00 €**

S1EH141

 Rotating  
 Ø 4.1 mm

*colored internal  
 prosthetic part*
**55.00 €**

S1EH141R



description | €

description | €

**ANATOMIC DEFINITIVE ANGLED ABUTMENTS**

S1EHR52 screw included | Material TI-6Al-4V

 Angled 15°  
 ∅ 5 mm  
 colored internal  
 prosthetic part

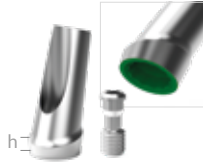
**75.00 €**

S1EH2 [X] 1550

Code	h (mm)
S1EH211550	1
S1EH231550	3

 Angled 25°  
 ∅ 5 mm  
 colored internal  
 prosthetic part

**75.00 €**

S1EH2 [X] 2550

Code	h (mm)
S1EH212550	1
S1EH232550	3

**CASTABLE ABUTMENTS**

S1EHR51 screw included | Material POM-C

 Gold base  
 POM-C /  
 AU&PGM  
 ∅ 4.1 mm

**110.00 €**

S1EH3GA

 Gold alloy AU60% PD15% PT24,9% IR0,1% AU e  
 PGM100%. Melting range. C° 1350/1460 Tensile  
 modulus GPa 110. Elastic limit MPa 450-720.  
 Stretching%18-12. Breaking load MPa 580-810.  
 Vickers hardness HV5/30 105-205-230.

 Gold base  
 rotante  
 POM-C /  
 AU&PGM  
 ∅ 4.1 mm

**110.00 €**

S1EH3GAR

 Gold alloy AU60% PD15% PT24,9% IR0,1% AU e  
 PGM100%. Melting range. C° 1350/1460 Tensile  
 modulus GPa 110. Elastic limit MPa 450-720.  
 Stretching%18-12. Breaking load MPa 580-810.  
 Vickers hardness HV5/30 105-205-230.

∅ 4.1 mm

**29.00 €**

S1EH3PC41

 Rotating  
 ∅ 4.1 mm

**29.00 €**

S1EH3PCR41

**STRAIGHT MUA ABUTMENTS**

Mounter included | Material TI-6Al-4V

∅ 4.1 mm

**55.00 €**

S1EH4 [X]

Code	h (mm)
S1EH41	1
S1EH42	2
S1EH43	3
S1EH44	4
S1EH45	5

 For MUA prosthetic components visit page 66  
 Tighten with HDH20 driver (page 80)

description | €

description | €

**ANGLED MUA ABUTMENTS**

S1EHR2 screw included | Mounter included | Material TI-6Al-4V

18°  
h 0/2 mm  
Ø 4.1 mm  
colored internal  
prosthetic part

**85.00 €**

S1EH518

30°  
Ø 4.1 mm  
colored internal  
prosthetic part

**85.00 €**

S1EH53 [X]

Code	h (mm)
S1EH532	0/2
S1EH534	2/4

For MUA prosthetic components visit page 66

**BALL ABUTMENTS**

cah e calt included | TIN Treatment on the gold part | Material TI-6Al-4V

Ø 4.1 mm  
**45.00 €**

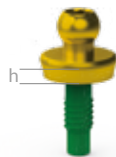

S1EH6 [X]

Code	h (mm)
S1EH61	1
S1EH62	2
S1EH63	3
S1EH64	4

 Containment  
ring

CAH

 Nylon  
containment  
cap

CALT

Tighten with MDS (page 81) or MDL (page 81) screwdriver

**CONTAINMENT RING and CONTAINMENT CAP**

Available as replacement

Material TI-6Al-4V

Containment  
ring  
**15.00 €**



CAH

Nylon  
containment  
cap  
**7.50 €**



CALT

description | €

description | €

**iRETOR** (Ring and cap not included)

TIN Treatment on the gold part

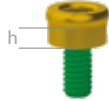
**TIN  
95.00 €**

S1EH8 [xx]

Code	h (mm)
S1EH80	0
S1EH81	1
S1EH825	2.5
S1EH835	3.5
S1EH845	4.5
S1EH865	6.5

Tighten with 8393 screwdriver (page 81)

**iRETOR ACCESSORIES**

 Analog for  
iRETOR®  
female coupling  
Q.ty: 4  
Al

**50.00 €**

8530

 Indirect  
impression  
tear pin for  
iRETOR®  
Q.ty: 4  
Al

**50.00 €**

8505

 Set of cups and  
rings for parallel  
implants  
Q.ty: 1  
Ti | Nylon

**27.50 €**

S1B85

 Resistant  
male  
(1.8 kg)  
Q.ty: 4

**30.00 €**

S1B8518

 Light  
male  
(1.2 kg)  
Q.ty: 4

**30.00 €**

S1B8512

 Extralight  
male  
(0.6 kg)  
Q.ty: 4

**30.00 €**

S1B8506

**CONICAL CONNECTION**  
2.1 mm | Bone Level

**Ø 3.3 - 3.7 - 4.1 - 4.7 - 5.2**



**UNIVERSAL SYSTEM FOR ALL TYPES OF BONES**

**FINE DOUBLE THREAD IMPLANT**

Ø	Implant thread	Connection	Platform	Hex	Thread
3.3 - 3.75 - 4.1 - 4.7 - 5.2	Fine double thread 0.6 mm	Cono-morse	Narrow	2.1 mm	1/72

	Ø 3.3	Ø 3.7	Ø 4.1	Ø 4.7 - 5.2
<b>Heights (mm)</b>	10   11.5   13   16	8   10   11.5   13   16	6.5   8   10   11.5   13   16	6.5   8   10   11.5   13
<b>Material</b>	Titanium Gr. 5	Titanium Gr. 5	Titanium Gr. 4	Titanium Gr. 4



- 1.** Platform switching, unique prosthesis for all the diameters
- 2.** 1 mm machined neck
- 3.** 60° double thread over the entire body implant with 5 a pitch of 1,2 mm (0,6 mm/ thread); each turn allows to go down of 1,2mm, speeding up the insertion phase
- 4.** 2 apical cuts helicoidal
- 5.** Conical apex flat tips
- 6.** 5° cone inclination on implant and abutment

It's proven that the cone-morse connection creates smaller slits (1µm) of bacteria (1,1-1,5µm length, 2-6µm diameter). Cone-morse connection absorbs vibration and chewing stress by eliminating the unscrewing of the screws (0.37%).

**Range of heights, from 2.5 to 4 mm, healing screws, temporary transfers and permanent abutments**

**NHSIC-C**

Neck Machined

**155,00**

**DRIVERS** Material Surgical steel



Description	Code
h 25 mm	HDH25S



Description	Code
h 30 mm	HDH25L

## CONICAL CONNECTION 2.1 mm | Bone Level

∅ 3.3 - 3.7 - 4.1 - 4.7 - 5.2

### IMPLANT CONNECTION

rationalization of prosthetic components

The **NHSIC** conical connection has a **5° angle** on the abutment and on the implant, and an emergence profile for the mucous attack. The **cone-morse** connection creates fissures (1µm) smaller than

bacteria, absorbs vibration and chewing stress with the result that it eliminates the unscrewing of the screws.

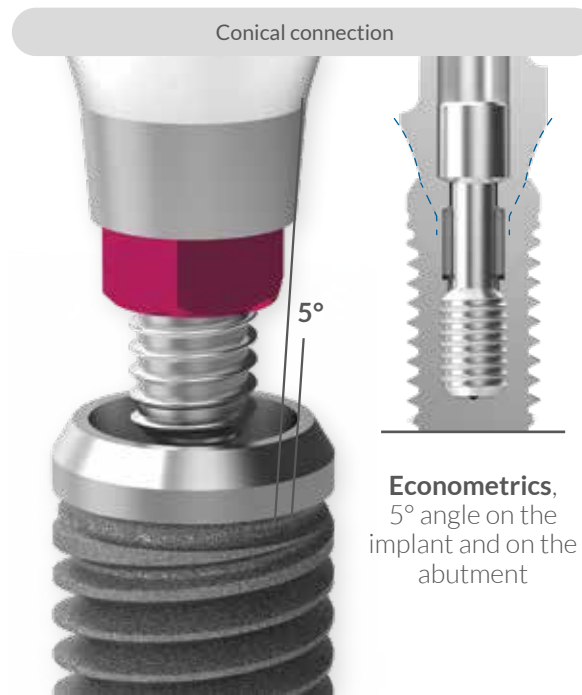

### MANAGEMENT OF SOFT TISSUES

The following configurations are available for improved soft tissue management.

Concave profile



description | €

description | €

**SURGICAL SCREWS**

provided with the implant, available as spare parts | Material Ti-6Al-4V

15.00 €



NHSICNCS

**PROSTHETIC SCREWS**

Maximum screwing torque 30 Ncm | Material Ti-6Al-4V

For abutment  
thread 1/72

15.00 €



S1BRS1

For MUA  
thread 1/72

15.00 €



S1BRS2

Long for  
transfer  
thread 1/72

15.00 €



S1BDTRS

Long for  
transfer MUA  
thread 1.4 mm

16.00 €



S1BDTRSA

Prosthetic  
screws torx

15.00 €



S1BRS1T6

**HEALING SCREWS**

S1BRS1 screw included | Material Ti-6Al-4V

∅ 4 mm

30.00 €



NHSICN40 [∞] HC

Code	h (mm)
NHSICN4030HC	3
NHSICN4045HC	4.5
NHSICN4060HC	6

description | €

description | €

ANALOG

Material TI-6Al-4V

Ø 4 mm

26.00 €



NHSICNIA

Guided surgery  
Ø 4 mm

30.00 €



NHSICNIAS

Digital analog

26.00 €



NHSICNDIA

DIGITAL SCAN ABUTMENT

S1BRS1 screw included | Material TI-6Al-4V

Titanium base

65.00 €



NHSICNSA

DIRECT TRANSFER IMPRESSION

S1BDTRS screw included | Material TI-6Al-4V

Ø 4 mm

45.00 €

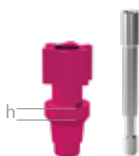

NHSICNDT [x] 40

Code	h (mm)
NHSICNDT140	1
NHSICNDT240	2
NHSICNDT440	4

description | €

description | €

PEEK TEMPORARY ABUTMENTS

S1BRS1 screw included | Material TI-6Al-4V

∅ 4 mm

50.00 €



Code	h (mm)
NHSICN1140PP	1
NHSICN1240PP	2
NHSICN1440PP	4

STRAIGHT ABUTMENTS

S1BRS1 screw included | Material TI-6Al-4V

∅ 4 mm

85.00 €



Code	h (mm)
NHSICN1140	1
NHSICN1240	2
NHSICN1440	4

STICKING BASES

S1BRS1 screw included | Material TI-6Al-4V

∅ 4 mm

75.00 €



Code	h (mm)
NHSICN1140SB	1
NHSICN1240SB	2
NHSICN1440SB	4

Rotating  
∅ 4 mm

75.00 €



Code	h (mm)
NHSICN1140RSB	1
NHSICN1240RSB	2
NHSICN1440RSB	4

DIGITAL T-BASE

S1BRS1 screw included | Material TI-6Al-4V

Not rotating

75.00 €



Code	h (mm)
NHSICN1DTB	1
NHSICN2DTB	2
NHSICN4DTB	4

Rotating

75.00 €



Code	h (mm)
NHSICN1DTBR	1
NHSICN2DTBR	2
NHSICN4DTBR	4



description | €

description | €

ANGLED ABUTMENTS

S1BRS2 screw included | Material TI-6Al-4V

Angled 15°  
Ø 4 mm

85.00 €



NHSICN2 [x] 1540

Code	h (mm)
NHSICN211540	1
NHSICN221540	2
NHSICN241540	4

Angled 25°  
Ø 4 mm

85.00 €



NHSICN2 [x] 2540

Code	h (mm)
NHSICN212540	1
NHSICN222540	2
NHSICN242540	4

CASTABLE ABUTMENTS GOLD BASE

S1BRS1 screw included

POM-C/  
AU&PGM  
Ø 4 mm

120.00 €



NHSICN3GA [x] 40

Code	h (mm)
NHSICN3GA140	1
NHSICN3GA240	2
NHSICN3GA440	4

Gold alloy AU60% PD15% PT24,9% IR0,1% AU e PGM100%. Melting range C° 1350/1460 Tensile modulus GPa 110. Elastic limit MPa 450-720. Stretching %18-12. Breaking load MPa 580-810. Vickers hardness HV5/30 105-205-230.

STRAIGHT MUA ABUTMENTS

Mounter included | Material TI-6Al-4V

Ø 4 mm

65.00 €



NHSICN4 [x]

Code	h (mm)
NHSICN41	1
NHSICN42	2
NHSICN43	3
NHSICN44	4

For MUA prosthetic components visit page 66  
Tighten with HDH20 driver (page 80)

LINK

Material TI-6Al-4V

Ø 3.5 mm

85.00 €



NHSICNL350 [x]

Code	h (mm)
NHSICNL3502	2
NHSICNL3503	3

Ø 4.1 mm

85.00 €



NHSICNL410 [x]

Code	h (mm)
NHSICNL4102	2
NHSICNL4103	3

description | €

description | €

**ANGLED MUA ABUTMENTS**

Mounter and S1BRS2 screw included | Material TI-6Al-4V

18°  
h 0/2 mm  
∅ 4 mm  
  
90.00 €



NHSICN518

30°  
∅ 4 mm  
  
90.00 €



NHSICN53 [X]

Code	h (mm)
NHSICN532	0/2
NHSICN534	2/4

For MUA prosthetic components visit page 66

**BALL ABUTMENTS**

cah e calt included | TIN Treatment on the gold part | Material TI-6Al-4V

∅ 4 mm  
  
55.00 €



NHSICN6 [X]

Code	h (mm)
NHSICN61	1
NHSICN62	2
NHSICN64	4

Containment ring



CAH

Nylon containment cap



CALT

Tighten with MDS (page 81) or MDL (page 81) screwdriver

**CONTAINMENT RING and CONTAINMENT CAP**

Available as replacement

Material TI-6Al-4V

Containment ring  
  
15.00 €



CAH

Nylon containment cap

7.50 €



CALT

description | €

description | €

**iRETOR** (Ring and cap not included)

TIN Treatment on the gold part

TIN  
95.<sup>00</sup> €

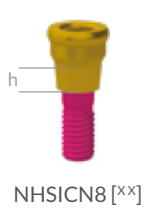

NHSICN8 [xx]

Code	h (mm)
NHSICN80	0
NHSICN81	1
NHSICN825	2
NHSICN835	3
NHSICN845	4
NHSICN865	6

Tighten with 8393 screwdriver (page 81)

**iRETOR ACCESSORIES**

Analog for  
iRETOR®  
female coupling  
Q.ty: 4  
Al

50.<sup>00</sup> €



8530

Indirect  
impression  
tear pin for  
iRETOR®  
Q.ty: 4  
Al

50.<sup>00</sup> €



8505

Set of cups and  
rings for parallel  
implants  
Q.ty: 1  
Ti | Nylon

27.<sup>50</sup> €



S1B85

Resistant  
male  
(1.8 kg)  
Q.ty: 4

30.<sup>00</sup> €



S1B8518

Light  
male  
(1.2 kg)  
Q.ty: 4

30.<sup>00</sup> €



S1B8512

Extralight  
male  
(0.6 kg)  
Q.ty: 4

30.<sup>00</sup> €



S1B8506

# OUR IMPLANT SYSTEMS

---

Reliable  
Efficient  
Safe

## SHAPEONE

---

- Tissue level with internal octagon  $\varnothing$  3.7 - 4.1 - 4.7
- Tissue level with internal hex  $\varnothing$  3.7 - 4.1 - 4.7

## iMAXMUA

---

- One Piece  $\varnothing$  3.3 - 3.7 - 4.1

## SHAPEMINI

---

- TIN ball attachment system  $\varnothing$  2.7

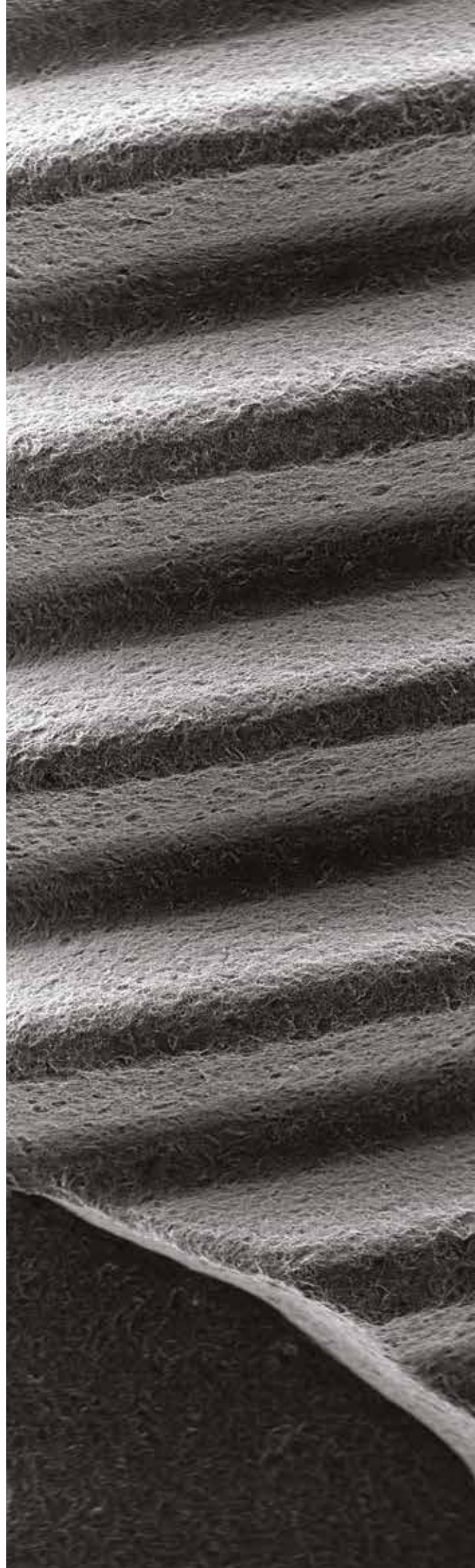

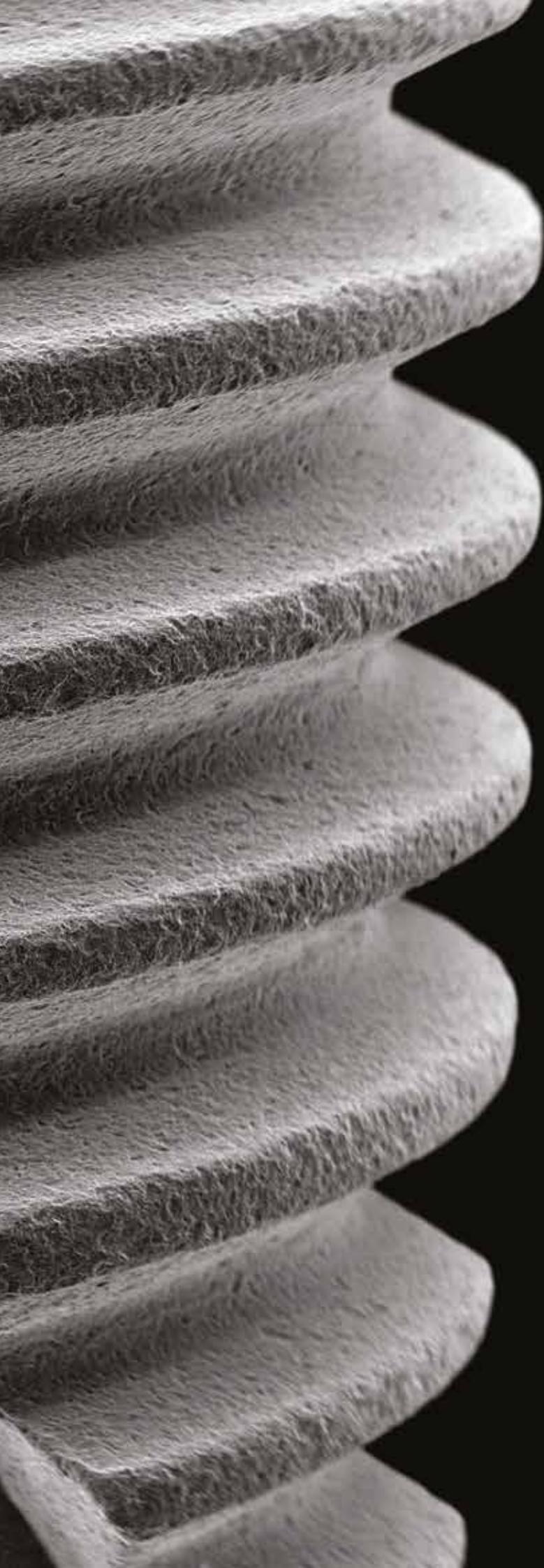

## TISSUE LEVEL IMPLANTS

---



EXCELLENT PRIMARY STABILITY ALSO IN BONE D4

FINE TRIPLE THREAD IMPLANT

Ø	Implant thread	Connection	Platform	Octagon	Thread
3.75 - 4.1 - 4.7	Triple	Intenal octagon	4.8 mm	3.1 mm	2 mm
<b>Ø 3.7</b>			<b>Ø 4.1 - 4.7</b>		
<b>Heights (mm)</b>	8   10   11.5   13   16		4.5   6.5   8   10   11.5   13   16		
<b>Material</b>	Titanium Gr. 5		Titanium Gr. 4		



1. Platform switching
2. Self tapping conical body
3. 60° triple thread over the entire body implant with a pitch of 1,8 mm
4. 3 apical aggressive cuts provide a better primary stability and centering of the implant and the possibility to change direction during its insertion
5. Apex aggressive but rounded to protect the Schneider's membrane

S1T-C

Neck Machined

150,00

**DRIVERS** Material Surgical steel



Description	Code
h 25 mm	HDH31S



Description	Code
h 30 mm	HDH31L

## IMPLANT CONNECTION

rationalization of prosthetic components

For the **S1T** line with internal **octagonal connection**, prosthetic components with cone inclined at  $16^\circ$  have been developed that prevent bacterial infiltration between implant and abutment.

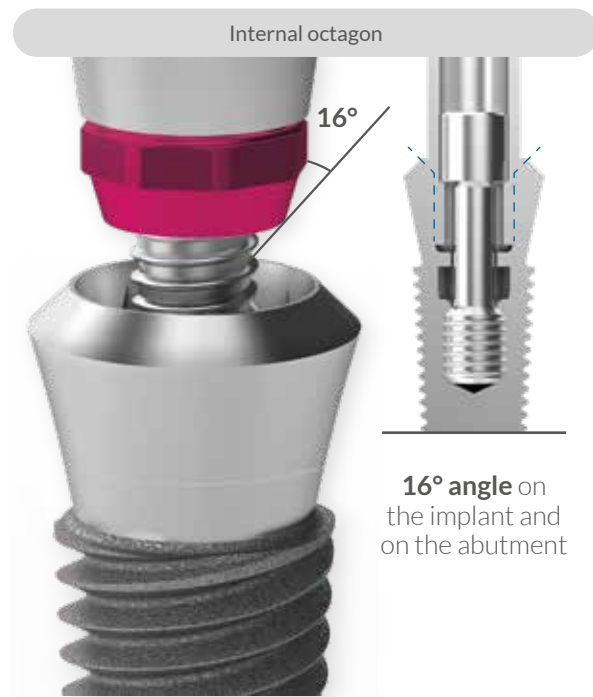

description | €

description | €

**SURGICAL SCREWS**

provided with the implant, available as spare parts | S1BRS1 screw included

Surgical screw  
Ø 4.8 mm  
thread 2 mm

15.00 €



S1TCS

**PROSTHETIC SCREWS**

Maximum screwing torque 30 Ncm

Material TI-6Al-4V

For abutment  
thread 2 mm

15.00 €



S1TRS1

For abutment  
thread 2 mm

15.00 €



S1TRS2

Long for  
transfer  
thread 2 mm

15.00 €



S1TDTRS

Torx screw  
for digital

15.00 €



S1TRS1T6

**ANALOG**

Material TI-6Al-4V

21.00 €



S1TIA

Digital  
analog

21.00 €



S1TDIA

**DIGITAL SCAN ABUTMENT**

S1TRS1 screw included | Material TI-6Al-4V

55.00 €



S1TSA

**DIGITAL T-BASE**

S1TRS1 and S1TRS1T6 screw included | Material TI-6Al-4V

Not rotating

75.00 €



S1T1DTB

Rotating

75.00 €



S1T1DTBR



description | €

description | €

**CASTABLE ABUTMENTS**

S1TRS1 screw included | Material POM-C

Ø 5 mm

29.00 €



S1T3PC50

Rotating  
Ø 5 mm

29.00 €



S1T3PCR50

**ABUTMENTS**

\*S1TRS1 screw included | \*\*S1TDTRS screw included | \*\*\*S1TRS2 screw included | Material TI-6Al-4V

Multifunction  
abutment  
Ø 5 mm

55.00 €



S1T1A50\*



S1T1A50L\*\*

Straight  
econometric  
connection  
abutment  
Ø 4.5 mm

75.00 €



S1T140\*

17° Angled  
econometric  
connection  
abutment  
Ø 4.5 mm

85.00 €



S1T240\*\*\*

**BALL ABUTMENTS**

Cap e Calt included | TIN Treatment on the gold part | Material TI-6Al-4V

Ø 4.5 mm

45.00 €



S1T6 [h]

Code	h (mm)
S1T60	0
S1T61	1
S1T62	2

Containment  
ring



CAH

Nylon  
containment  
cap



CALT

Tighten with MDS (page 81) or MDL (page 81) screwdriver

**CONTAINMENT RING and CONTAINMENT CAP**

Available as replacement

Material TI-6Al-4V

Containment  
ring

15.00 €



CAH

Nylon  
containment  
cap

7.50 €



CALT

SHAPEONE

EXCELLENT PRIMARY STABILITY ALSO IN BONE D4

## FINE TRIPLE THREAD IMPLANT

Ø	Implant thread	Connection	Platform	Hex	Thread
3.75 - 4.1 - 4.7	Triple thread 0.9 mm	Internal hex	3.5 mm	2.5 mm	1/72
<b>Ø 3.75</b>			<b>Ø 4.1 e Ø 4.7</b>		
<b>Heights (mm)</b>	8   10   11.5   13   16		4.5   6.5   8   10   11.5   13   16		
<b>Material</b>	Titanium Gr. 5		Titanium Gr. 4		



1. Platform switching
2. 3 mm machined implant
3. Self tapping conical body
4. 60° triple thread over the entire body implant with a pitch of 1,8 mm
5. 3 apical aggressive cuts provide a better primary stability and centering of the implant and the possibility to change direction during its insertion
6. Apex aggressive but rounded to protect the Schneider's membrane

SHAPEONE TNC	<b>S1TN-C</b>
	Neck Machined
SHAPEONE TNC	<b>135,00</b>

## DRIVERS

Material Surgical steel



Description

Code

h 25 mm

HDH25S



Description

Code

h 30 mm

HDH25L

## IMPLANT CONNECTION

rationalization of prosthetic components

Prosthetic components with **Friction Fit** connection have been developed for **S1TN** implant systems with **internal hex** connection. This connection ensures a **“cold fusion”** between implant and

abutment if the retaining screw has been tightened at 30 Ncm. It eliminates micro movements and reduces bacterial infiltration between implant and abutment.



description | €

description | €

PROSTHETIC SCREWS

Maximum screwing torque 30 Ncm Material TI-6Al-4V

For abutment  
thread 1/72

15.00 €



S1BRS1

For abutment  
thread 2 mm

15.00 €



S1TRS2

Long for  
transfer  
thread 1/72

15.00 €



S1BDTRS

Prosthetic  
screws torx

15.00 €



S1BRS1T6

ANALOG

Material TI-6Al-4V

22.00 €



S1TNIA [x]

Code	Ø
S1TNIA37	3.7 mm
S1TNIA41	4.1 mm
S1TNIA47	4.7 mm

## DIRECT IMPRESSION TRANSFER

S1BDTRS screw included | Material TI-6Al-4V

Mounter  
transfer  
definitive  
straight  
abutment  
Ø 3.5 mm



Code	Ø
S1TN1A35L	3.5 mm
S1TN1A37L	3.7 mm
S1TN1A41L	4.1 mm
S1TN1A47L	4.7 mm

55.00 €

S1TN1A [x] L

## INDIRECT IMPRESSION TRANSFER

S1BRS1 screw included | Material TI-6Al-4V

Mounter  
transfer  
definitive  
straight  
abutment



Code	Ø
S1TN1A35	3.5 mm
S1TN1A37	3.7 mm
S1TN1A41	4.1 mm
S1TN1A47	4.7 mm

55.00 €

S1TN1A [x]



UNIVERSAL SYSTEM FOR ALL TYPES OF BONES

FINE DOUBLE THREAD IMPLANT

Ø	Implant thread	Connection	Platform	Angolo
3.3 - 3.75 - 4.1	Double	One Piece	4.3 mm	0°
3.75 - 4.1	Double	One Piece	4.3 mm	18° e 30°

	Ø 3.3 - 3.75	Ø 4.1
Heights (mm)	4.5   6   8   10   11.5   13	4.5   6   8   10   11.5   13
	(NHSM18) Ø 3.7 - 4.1	(NHSM30) Ø 3.7 - 4.1
Heights (mm)	11.5   13	11.5   13   16
Material	Titanium Gr. 5	Titanium Gr. 4



1. Hole for retaining screw
2. 1.5mm machined neck
3. Cylindrical body
4. 60° double thread over the entire body implant with a pitch of 1,2 mm 3 (0,6 mm/ thread); each turn allows to go down of 1,2mm, speeding up the insertion phase.
5. 2 apical helicoidal cuts
6. Conical flat tip apex



DRIVERS

Material Surgical steel



NHSM00-HYHA		Hybrid
0°	18°	30°
195,00	225,00	225,00



Description	Code
Implant driver	NHSMHDH

IMPLANT CONNECTION

rationalization of prosthetic components

There is no connection between implant and abutment in **NHSM ONEPIECE** system and this allows to **completely eliminate bacterial infiltration**. OnePiece connection is suitable for immediate loading.



description | €

description | €

**RETAINING SCREWS**

Maximum screwing torque 30 Ncm | Material TI-6Al-4V

Retaining screw for abutment thread 1/72

15.00 €



NHSMRS1

Long retaining screw for MUA transfer thread 1/72

15.00 €



NHSMDTRS

**HEALING CAPS**

NHSMRS1 screw included | Material TI-6Al-4V

Healing cup TI-6Al-4V

25.00 €



NHSMHCSRA

Healing cup POM-C

25.00 €



NHSMHCSRAA

**ANALOG**

Material TI-6Al-4V

21.00 €



NHSMIASRA

Digital analog

21.00 €



NHSMDIASRA

**DIGITAL SCAN ABUTMENT**

NHSMRS1 screw included | Material TI-6Al-4V

55.00 €



NHSMCAA

**IMPRESSION TRANSFER**

\*NHSMRS1 screw included | \*\*NHSMDTRS screw included | Material TI-6Al-4V

Indirect

55.00 €



NHSMITCSRA\*

Direct

35.00 €



NHSMDTCSRA\*\*



description | €

description | €

**DIGITAL T-BASE**

NHSMRS1 screw included | Material TI-6Al-4V

Rotating

65.00 €



NHSMTTADTB

**ABUTMENTS**

NHSMRS1 screw included | Material TI-6Al-4V

Temporary straight abutments

55.00 €



NHSMPPTA

Definitive straight abutments

55.00 €



NHSMTTA

Castable abutments

29.00 €



NHSMPCC

Abutments for welded technique

55.00 €



NHSMTS

**THREADED ANTI ROTATION**

NHSMRS1 screw included | Material TI-6Al-4V

55.00 €

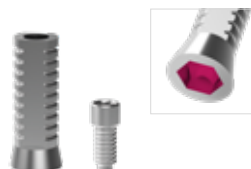

NHSMTTAE

**THREADED ABUTMENTS FOR BAR**

NHSMRS1 screw included | Material TI-6Al-4V

55.00 €



NHSMTTAFB

SHAPEMINI

EXCELLENT PRIMARY STABILITY ALSO IN BONE D4

## SELF-TAPPING IMPLANT WITH SINGLE THREAD

## TECHNICAL FEATURES

Ø	Implant thread	Connection
2.7	Single	Tin ball attachment system
<b>Ø 2.7</b>		
<b>Heights (mm)</b>	8   10   11.5   13   16	
<b>Material</b>	Titanium Gr. 4	



**1.** Ball attachment system, ideal for overdenture

**2.** Self-tapping cylindrical body with single thread, pitch of 1.2 mm

**3.** Thread with lower angle of 43° and upper of 23°

Tighten with HDH25M (page 80) driver

SHAPEMINI

**SM**

Tin ball attachment system

SHAPEMINI

**55,00**

description | €

description | €

**ANALOG**

Material TI-6Al-4V

21.00 €



SMIA

**CASTABLE ABUTMENT**

Material POM-C

29.00 €



SMC

**CONTAINMENT RING and CONTAINMENT CAP**

Material TI-6Al-4V

Containment ring

15.00 €



CAH

Nylon containment cap

7.50 €



CALT

description | €

description | €

RETAINING SCREWS

Maximum screwing torque 30 Ncm | Material TI-6Al-4V

Retaining screw for abutment

15.00 €



S1BRS3

Long retaining screw for MUA transfer thread 1/72

15.00 €



S1BDTRSA

HEALING CAPS

S1BRS3 screw included | Material TI-6Al-4V

Healing cup TI-6Al-4V

25.00 €



S1BHCSRA

Healing cup POM-C

25.00 €



S1BHCSRAA

ANALOG

Material TI-6Al-4V

21.00 €



S1BIASRA

Digital analog

21.00 €



S1BDIASRA

DIGITAL SCAN ABUTMENT

S1BRS3 screw included | Material TI-6Al-4V

55.00 €



S1BSAA

INDIRECT IMPRESSION TRANSFER

S1BRS3 screw included | Material TI-6Al-4V

55.00 €



S1BITCSRA

description | €

description | €

**DIRECT IMPRESSION TRANSFER**

S1BDTRSA screw included | Material TI-6Al-4V

With long screw

35.00 €



S1BDTCSRA

**ABUTMENTS**

S1BRS3 screw included | Material TI-6Al-4V

Temporary straight abutments

55.00 €



S1BPPTA

Definitive straight abutments

55.00 €



S1BTTA

Castable abutments

29.00 €



S1BPCC

Abutments for welded technique

55.00 €



S1BTS

**DIGITAL T-BASE**

S1BRS3 screw included | Material TI-6Al-4V

Rotating

65.00 €



S1BTTADTB

**THREADED ANTI ROTATION**

S1BRS3 screw included | Material TI-6Al-4V

55.00 €



S1BTTAE

**THREADED ABUTMENTS FOR BAR**

S1BRS3 screw included | Material TI-6Al-4V

55.00 €



S1BTTAFB





Swiss  
implant  
quality



## SURFACE TREATMENT

SLA type

There is a relevant scientific literature\* on how surface roughness characteristics influence cell behaviour. Compared to a smooth surface, topographical patterns smaller in size than a fibroblast cell (micro and nano topography) orient the arrangement of the cells and stimulate osteoblastic and platelet activity, accelerating the production of extracellular matrix and bone regeneration, and therefore the osseointegration of the dental implant. The three fundamentals of surface treatment of dental implants from a biological point of view are:

- 1) control of surface topography to stimulate cellular response in an osteogenic direction;
- 2) control of the chemical composition of the surface to promote cell colonization;
- 3) control of biological contamination from adherent endotoxins so as not to interfere with the natural inflammatory response. For the surface treatment a sand-blasting process was used followed by a double acid attack. In the images, increasing the magnification, it can be seen how the macroscopic aspects of the screw (spire, cutting SLA surface

treatment edge) are not affected by the treatment and that the surface is free from processing residue. The dual-beam roughness typical of SLA treatment can be clearly observed, which contains large cavities due to large grit blasting on which is superimposed the micro-roughness due to treatment with acids. The micro-roughness illustrated in the figures highlights the typical three-dimensional topography, which gives these surfaces "sponge-like" characteristics that are the basis of their excellent clinical performance. In fact, the very short peak-to-peak distance, about 1 micrometer, stimulates both the activity of osteogenic cells and the capillary penetration of the blood in the surface structure, offering very favorable characteristics to stimulate bone regeneration, as described in many articles on this topic. This unique combination of long-range roughness (large grit sand-blasting) and short-range (acid etching) is a substrate favorable to cell regrowth that adequately promotes cell differentiation. The level of roughness is  $Ra\ 1.42 \pm 0.12$ .

## NECK MACHINED

C

Surface treatment on the body implant

## HYALURONIC ACID

HYHA

Partial surface treatment on the body implant with hyaluronic acid.  
Cold plasma decontamination\*

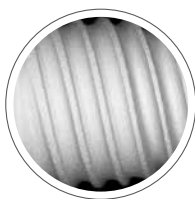

MAG  
52 X  
WD  
11.5 mm  
EHT  
20.00 kV  
Signal A  
CZ BSD



MAG  
200 X  
WD  
11.0 mm  
EHT  
20.00 kV  
Signal A  
CZ BSD

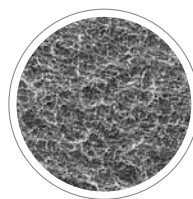

MAG  
1.50 K X  
WD  
11.5 mm  
EHT  
20.00 kV  
Signal A  
SE1

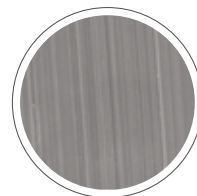

**Sa 0,50 µm**  
overall mean value on  
a measuring area of  
30x30 µm  
cold plasma  
decontamination

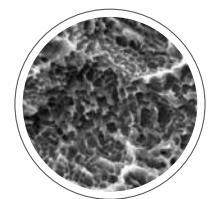

**Sa 1,90 µm**  
overall mean value on  
a measuring area of  
30x30 µm  
sand-blasting, double  
etching, cold plasma  
decontamination

\* Valutazione della composizione chimica superficiale, della morfologia, della citotossicità e dell'adesione cellulare su impianti dentali. G. Cascardo, C. Cassinelli. Doctor OS 2005 Nov-Dic; 16 (9): 1091. Valutazione comparativa del trattamento di superficie in 5 sistemi implantari. M. Biasotto, M. Cadernaro et al. Università degli studi di Trieste. Quintessence International. Anno 18 - Maggio/Giugno 2002. RAPPORTO ISTISAN 01/15 - Valutazione del trattamento superficiale sulle prestazioni meccaniche a fatica di impianti in titanio plasma-sprayed e titanio sabbato e mordenzato. Rossella Bedini, Gior-gio de Angelis, Marco Tallarico, Rosario Ielpi, Umberto Romeo, Giuseppe di Cintio 2001, 33 p. RAPPORTO ISTISAN 08/32 - Valutazione microtomografica dell'area di

possibile contatto osseo di sei tipologie diverse di impianti dentali. Rossella Bedini, Raffaella Pec-ci, Fabio Di Carlo, Alessandro Quaranta, Francesca Rizzo, Manlio Quaranta, G. Heimke, W. Schulte, B. d'Hoedt, P. Griss, C.M. Büsing, D. Stock. The influence of fine surface structures on the osseointegration of implants. The International Journal of Artificial Organs 1982; 5(3): 207-212. Guy, M.J. McQuade, M.J. Scheidt, J.C. McPherson III, J.A. Rossmann, T.E. Van Dyke. In vitro attachment of human gingival fibroblasts to endosseous implant materials. Journal of Periodontology 1993 Jun; 64(6): 542-546.



## CYTOTOXICITY TEST

EN ISO 10993-5: 2009, Valutazione Biologica dei Dispositivi Medici - Prove per la citotossicità in vitro

After treatment and decontamination, the implants proved to be perfectly cytocompatible, that is devoid of cytotoxic effects against L929 fibroblasts. In all wells, the cells always showed density and morphology fully comparable with those of the negative control. The fibroblasts proliferate homogeneously in contact with the implants as the

Material does not release any cytotoxic element. Moreover, multinucleated giant cells were never shown in significantly higher number than the negative control, indicating the absence of effects of an inflammatory type.

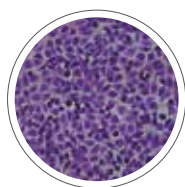

negative control

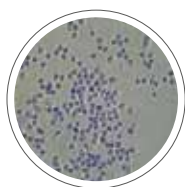

positive control

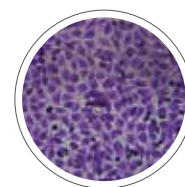

examined control

## COLD PLASMA DECONTAMINATION

After the surface treatment, the implants are cleaned to remove processing residues by washing them with solvents and then subjecting them to a process of surface decontamination with cold plasma (Argon). The partially ionized Argon atoms (inert gas) act as an additional atomic sand-blasting that promotes the removal of organic contaminants and activates the ionization of surface atoms of titanium, improving the wettability of the implant. The treatment conditions adopted on shape1 implants offer the best characteristics considered important, according to the state of current knowledge\*, in the

processes of implant healing, both in terms of surface morphology and in terms of chemical composition (surface cleaning). Plasma cleaning, packaging in a controlled environment, the absolute respect of "clean" procedures, quality control tests of during the manufacturing process, play a fundamental role in the control of adherent endotoxins (biological cleaning), the main agent of immunological response to implant surfaces.

\* Valutazione del rapporto tra costo e qualità della pulizia superficiale di alcuni sistemi implantari in commercio  
Marco Morra, Clara Cassinelli, Giovanna Cascardo, Daniele Bollati, Nobil Bio Ricerche srl Via Valcastellana 26, 14037, Portacomaro (AT)

M. Morra, C.Cassinelli, Evaluation of Surface Contamination of Titanium Dental Implants by Lu-Sem: Comparison with XPS Measurements Surface and Interface Analysts, Vol. 25, 983-984 (1997).

## STERILIZATION & PACKAGING

To preserve its integrity, the dental implant is housed in a vertical position inside a titanium cylinder anchored, by means of the closing cap, to the respective vial made of borosilicate glass for pharmaceutical use, complying with the European Pharmacopoeia in force. This vial really ensures the neutrality of the primary packaging due to the absence of release of contaminants during the sterilization phase. It is inserted in a blister of transparent polyglass sealed with heat-sealing lacquer-based Tyvek and packed in a cardboard box that also contains the instructions for use and the labels for the patient records, on which are printed the data that allow product traceability (code and batch number). All the product packaging Materials have

been tested, approved and certified.

Shape1® implants are supplied sterile, in a pack that allows their stability to be guaranteed for 5 years. The sterilization process is performed with gamma rays respecting the standards in force by qualified suppliers who use automated, safe and reliable systems, with continuous microbiological monitoring of the process.



\*European Pharmacopoeia, current edition, 3.2.1 Glass containers for pharmaceutical use.

# PROSTHETIC INSTRUMENTS PROTOCOL AND SURGICAL KIT

one surgical kit for all the implant systems

The purpose of **surgical trays** is to store the instruments used to insert dental implants. The kit can be carried, sterilized and kept in a horizontal position with the lid closed. All the instruments must be cleaned and sterilized before the first use. **The surgical kit and instruments are not sterile at the time of delivery.**



## CLEANING

- 1- Dismantle all the compound parts.
- 2- Rinse abundantly with cold or lukewarm water for 2-5 minutes.
- 3- Leave the instruments for 10 minutes in an ultrasonic cleaner with a neutral pH enzymatic detergent diluted in water according to the product instructions.
- 4- Wash the instruments with water for 3 minutes.

## STERILIZATION

The guidelines for sterilization are listed below. Exceeding these sterilization limits may cause deterioration of the plastic components.

Type of cycle (value)	Temperature (°C - F)	Exposure	Drying time
Pre-vacuum	132 / 270	3 minutes	30 minutes
Pre-vacuum	134 / 273	18 minutes	30 minutes
Gravity	121 / 250	80 minutes	30 minutes

## THE DRILLS

For a proper osteotomy and to maintain the integrity of bone quality, the maximum recommended speed is 800rpm with direct input on drill of saline solution to facilitate cooling. All drills are made of medical stainless steel and subjected to hardening heat treatment. Maximum recommended number of use of the devices 30 times.

The helical milling cutters have reference laser markings that identify the depth to reach, until 8mm

with a thin white line, from 10 to 13mm with a white band in which at half is identified the 11.5mm height, and finally a thin white line for the 16mm. This system gives a clear and intuitive glance of the depth level reached by the drill. 4.5 and 6.5mm are not present to avoid confusion in reading the demarcation lines, and being these measures close to the nerve, it is always recommended to use stop by 4.5 and 6.5mm.

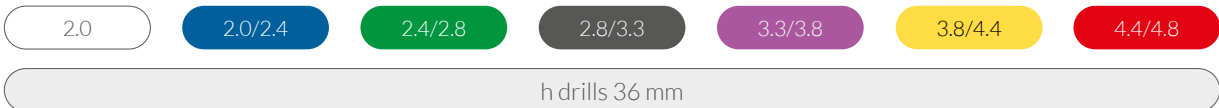

The drills from 2.0 to 2.8 / 3.3 have a sharp apex. The drills from 3.3/3.8 - 3.8/4.4 - 4.4/4.8 have a flat apex, they do not increase the height of the cut, but are only used to widen the osteotomy. They must not be used for cutting, but as an aid for inserting the implant.

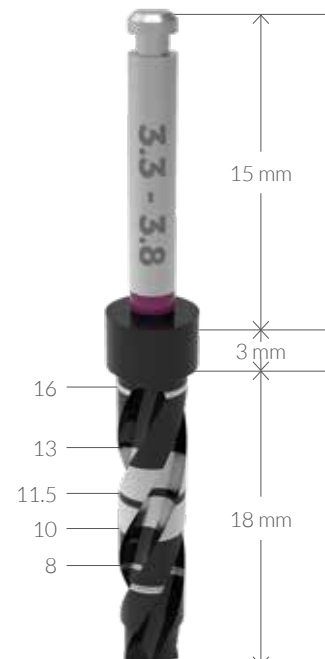
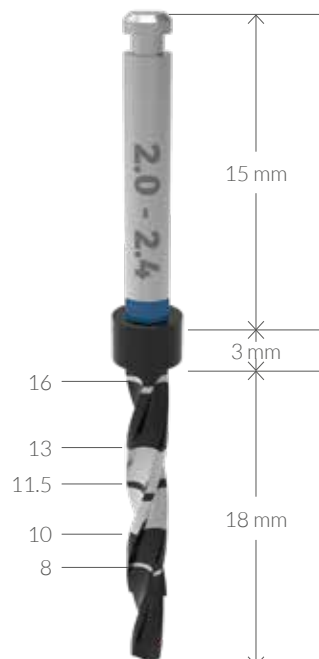
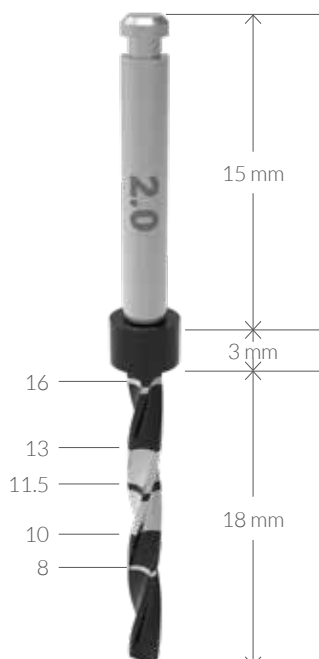
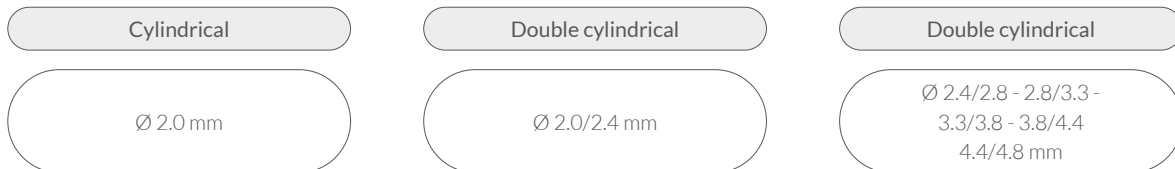

## THE COUNTERSINKS

The countersinks are used when there is the need to enlarge the initial part of the hole created to adapt this shape to the neck of the implant to be inserted. The maximum recommended speed is 300rpm with direct input on drill of saline solution to facilitate cooling. The countersink should be used in perfect axis with the osteotomy to avoid its ovalization in the coronal part.

The countersinks present two laser markings that identify the depth to be reached on the basis of the bone consistency, at 1.4mm for a "D3" bone, at 2.8mm for both "D2" and "D1" bones. Above the marking at 2.8mm, the countersink continues with a cylindrical geometry that does not compromise the osteotomy although more deeply inserted.



## THE TAPS

In very dense bone (Type I) it is recommended to use a tap with the same system profile to insert. The tap is sharper than the implant and it allows to prepare the implantation site with reduced trauma.

The maximum recommended speed is 30 rpm with direct input on tap of saline solution to facilitate cooling.



## THE STOPS

The length of the stops ranges from 4.5mm to 13mm and they are available for all the implant lengths. 33/38

- 38/44 - 44/48 are flathead drills. They can not be used to cut, but only to help you to insert the implant.



## RATCHET 10/100 NCM and CONNECTORS

In the kit all the connectors have a handpiece attack that may be used both in manual mode and with the ratchet, thanks to the special washer (WH2). The insertion torque for the immediate loading will be in the range from 35 to 50Ncm. For the conventional load the insertion torque should never exceed 70Ncm.

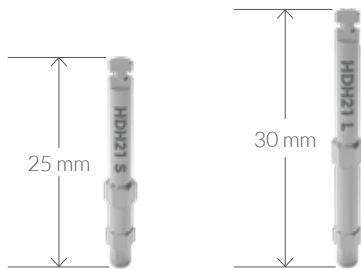

1. The new ratchet uses connectors with HANDLE ATTACK

2. the DRIVE HEXAGON confers greater solidity during the tightening phase

3. POSITION HEXAGON during the insertion allows to see the internal positioning of the hexagon

4. HEXAGON CONNECTION that reaches the stop of the system, has a steel retention ring reinforced and raised both to avoid interferences during the implant insertion and to reduce the wear of the retention



## RATCHET ADAPTOR

Code: **WH2**  
 Ø 8 mm reinforced  
 that adding solidity



## REVERSE FIXED RATCHET + RATCHET WRENCH

Code: **TW4**

### Reverse fixed ratchet

It allows to screw and unscrew without having to pull out and turn the adapter

### Ratchet wrench

mounted on the reverse ratchet, it allows to measure up to 100Ncm<sup>2</sup> without breaking the rod through the stop final race



## REVERSE FIXED RATCHET + RATCHET ADAPTOR + RATCHET WRENCH

Code: **TWA2**



Housing for 8mm washer to confer greater resistance to higher torque.



Reverse to change direction of unscrewing and screwing without having to remove and replace the ratchet.



Under the 100Ncm is present a safety catch to prevent the leakage of the dragging arm, avoiding its breakage.

## SURGICAL KIT COMPOSITION



Code	Description	Code	Description
DE	drill extender	CSD52	countersink Ø 5.2
LD	lance drill	DS43341M	stop 4.5
D20M	pilot drill Ø 2.0	DS63341M	stop 6.5
D2024M	drill Ø 2.0 2.4 mm	DS83341M	stop 8
D2428M	drill Ø 2.4 2.8 mm	DS103341M	stop 10
D2833M	drill Ø 2.8 3.3 mm	DS113341M	stop 11.5
D3338M	drill Ø 3.3 3.8 mm	DS133341M	stop 13
D3844M	drill Ø 3.8 4.4 mm	TWA2	complete ratchet
D4448M	drill Ø 4.4 4.8 mm	THDDS	short driver
CSD33	countersink Ø 3.3	THDDL	long driver
CSD37	countersink Ø 3.7	PP	parallel pin 0°
CSD41	countersink Ø 4.1	PP18	parallel pin 18°
CSD47	countersink Ø 4.7	PP30	parallel pin 30°

### INTERNAL HEX DRIVERS

Code	Description	Hex
HDH21S	short driver hex 2.1	internal
HDH21L	long driver hex 2.1	internal
HDH25S	short driver hex 2.5	internal
HDH25L	long driver hex 2.5	internal

### EXTERNAL OCTAGON DRIVERS

Code	Description	Octagon
HDH31S	short driver oct. 3.1	external
HDH31L	long driver oct. 3.1	external

## SMALL SURGICAL KIT COMPOSITION



### BASIC

Code	Description
LD	lance drill
D20M	pilot drill Ø 2.0
D2024M	drill Ø 2.0 2.4 mm
D2428M	drill Ø 2.4 2.8 mm
D2833M	drill Ø 2.8 3.3 mm
D3338M	drill Ø 3.3 3.8 mm
D3844M	drill Ø 3.8 4.4 mm
D4448M	drill Ø 4.4 4.8 mm
CSD33	countersink Ø 3.3
CSD37	countersink Ø 3.7
CSD41	countersink Ø 4.1
CSD47	countersink Ø 4.7
CSD52	countersink Ø 5.2
THDDL	long driver
HDH21L	long driver hex 2.1
HDH25L	long driver hex 2.5
TWA2	complete ratchet

### COMPLETE

Code	Description
DE	drill extender
TAPXXX33	tap Ø 3.3
TAPXXX37	tap Ø 3.7
TAPXXX41	tap Ø 4.1
TAPXXX47	tap Ø 4.7
TAPXXX52	tap Ø 5.2
PP	parallel pin 0°
PP18	parallel pin 18°
PP30	parallel pin 30°
THDDS	short driver
HDH21S	short driver hex 2.1
HDH25S	short driver hex 2.5
MDS	S prosthetic screwdriver
MDL	L prosthetic screwdriver
MDLAA	prosthetic screwdriver angled 30°
DS43341M	stop 4.5
DS63341M	stop 6.5
DS83341M	stop 8
DS103341M	stop 10
DS113341M	stop 11.5
DS133341M	stop 13

description | €

description | €

DRILL EXTENDER

Material Surgical steel

40.00 €



DE

LANCE DRILL

Material Surgical steel

Ø 2 mm

45.00 €



LD

TISSUE PUNCH

Material Surgical steel

Ø 3.3 mm

48.00 €



HDHCSN

Ø 4 mm

48.00 €



HDHCSR

DRILLS

Material Surgical steel

Media  
h 36 mm

70.00 €



Ø 2 mm  
D20M



Ø 2.0|2.4 mm  
D2024M



Ø 2.4|2.8 mm  
D2428M



Ø 2.8|3.3 mm  
D2833M



Ø 3.3|3.8 mm  
D3338M



Ø 3.8|4.4 mm  
D3844M



Ø 4.4|4.8 mm  
D4448M

COUNTERSINK

Material Surgical steel

90.00 €



Ø 3.3 mm  
CSD33



Ø 3.7 mm  
CSD37



Ø 4.1 mm  
CSD41



Ø 4.7 mm  
CSD47



Ø 5.2 mm  
CSD52



description | €

description | €

## ShapeOne® TAPS

Material Surgical steel

90.00 €

Ø 3.7 mm  
TAPS1B37Ø 4.1 mm  
TAPS1B41Ø 4.7 mm  
TAPS1B47

## iMAX® TAPS

Material Surgical steel

90.00 €

Ø 3.3 mm  
TAPIMAX33Ø 3.7 mm  
TAPIMAX37Ø 4.1 mm  
TAPIMAX41Ø 4.7 mm  
TAPIMAX47Ø 5.2 mm  
TAPIMAX52

## STOPS FOR DRILLS - 2.0 / 2.0/2.4 - 2.4/2.8 - 2.8/3.3

Material Ti-Gr4

35.00 €

h 4 mm  
DS43341Mh 6 mm  
DS63341Mh 8 mm  
DS83341Mh 10 mm  
DS103341Mh 11 mm  
DS113341Mh 13 mm  
DS133341M

## PARALLEL PINS

Material Ti-Gr4

20.00 €

0°  
PP18°  
PP1830°  
PP30

## DRIVERS

Material Surgical steel

Internal  
Hex 2.1 mm  
Narrow  
h 25 mm

45.00 €



HDH21S

Internal  
Hex 2.1 mm  
Narrow  
h 30 mm

45.00 €



HDH21L

description | €

description | €

## DRIVERS

Material Surgical steel

External  
Hex 2.4 mm  
Narrow  
h 25 mm

45.00 €



HDH24S

External  
Hex 2.4 mm  
Narrow  
h 30 mm

45.00 €



HDH24L

For internal  
Hex 2.5 mm  
Regular  
h 25 mm

45.00 €



HDH25S

For internal  
Hex 2.5 mm  
Regular  
h 30 mm

45.00 €



HDH25L

For external  
Hex 2.7 mm  
Regular  
h 25 mm

45.00 €



HDH27S

For external  
Hex 2.7 mm  
Regular  
h 30 mm

45.00 €



HDH27L

For octagon  
3.1 mm  
h 25 mm

45.00 €



HDH31S

For octagon  
3.1 mm  
h 30 mm

45.00 €



HDH31L

For  
straight MUA

45.00 €



HDH20

For Mini  
implants  
2 mm

45.00 €



HDH25M

For OnePiece  
da 4.5mm

45.00 €



NHSMHDH

description | €

description | €

## ORIENTER POSITION

Material Surgical steel

For OnePiece  
NHSM

21.00 €



NHSMFL

## GUIDE TO DRILL INCLINATION

Material Surgical steel

0° - 18° - 30°

120.00 €



NHSMG

## PROSTHETIC SCREWDRIVERS

Material Surgical steel

For Hex  
1.25 mm  
contra-angle  
connection  
short

45.00 €



THDDS

For Hex  
1.25 mm  
contra-angle  
connection  
long

45.00 €



THDDL

For hex  
1.25 mm  
manual  
h 23 mm

45.00 €



MDS

For hex  
1.25 mm  
manual  
h 29 mm

45.00 €



MDL

Torcx  
1.25 mm  
manual  
angled  
h 29 mm

65.00 €



MDLA

Torcx  
1.25 mm  
manual  
angled 30°

65.00 €



MDLAA

## SCREWDRIVERS

Material Surgical steel

Long

65.00 €



IDL

For iRETOR®

95.00 €



8393

description | €

description | €

REMOVAL TOOLS

Material Surgical steel

For implants

95.00 €



TRI

For abutments

95.00 €



TRT

EXTRACTION KIT FOR RETAINING SCREWS

Material Surgical steel

Drill

110.00 €



D15RS

Guide for drills

60.00 €



GRS

Holder for GRS

100.00 €



SGRS

RATCHET

Material Surgical steel

Reverse fixed ratchet + Ratchet wrench

230.00 €



TW4

Ratchet adaptor

50.00 €



WH2

Complete ratchet

280.00 €



TWA4

## PROSTHETIC KIT COMPOSITION



\*available on request

Code	Description
MDS	short screwdriver hex 1.25 mm h 23 mm
MDL	long screwdriver hex 1.25 mm h 29 mm
TRT	removal tool for abutments
HDH20	Implant driver for straight MUA
THDDS	short prosthetic screwdriver hex 1.25
THDDL	long prosthetic screwdriver hex 1.25
TWA4	ratchet wrench
MDLA*	angled screwdriver hex 1.25 mm h 29 mm

## SINUS LIFT COMPOSITION



Code	Description
DE	drill extender
SPD	standard pilot drill
SPI	standard start drill
SD5	standard drill h 5 mm
SD6	standard drill h 6 mm
SD7	standard drill h 7 mm
SD8	standard drill h 8 mm
SBL	standard body lift

Code	Description
APD	advanced pilot drill
AID	advanced start drill
AD2	advanced drill h 2 mm
AD3	advanced drill h 3 mm
AD4	advanced drill h 4 mm
ABL	advanced body lift
RBL	ratchet body lift





heights from 8 to 16 mm

## ShapeOne

S1B - S1T - S1Tn

∅	Heights
3.7	
4.1	h 8 - 10 - 11.5 - 13 - 16 mm
4.7	

## iMAX

NHSI - NHSE

∅	Heights
3.3	h 10 - 11.5 - 13 - 16 mm
3.7	
4.1	h 8 - 10 - 11.5 - 13 - 16 mm
4.7	
5.2	h 8 - 10 - 11.5 - 13 mm

## iMAX

NHSIC

∅	Heights
3.3	h 10 - 11.5 - 13 - 16 mm
3.7	
4.1	h 8 - 10 - 11.5 - 13 - 16 mm
4.7	
5.2	h 8 - 10 - 11.5 - 13 mm

## iMAX MUA OnePiece

NHSM

Angolo	∅	Heights
0°	3.3	
	3.7	h 10 - 11.5 - 13 mm
	4.1	
18°	3.7	h 11.5 - 13 mm
	4.1	
30°	3.7	h 11.5 - 13 - 16 mm
	4.1	

## Volution

SVB

∅	Heights
3.3	h 10 - 11.5 - 13 - 16 mm
3.7	
4.1	h 8 - 10 - 11.5 - 13 - 16 mm
4.7	
5.2	h 8 - 10 - 11.5 - 13 mm



**DRIVERS- FINAL DRILLS- COUNTERSINKS - TAPS**

heights from 8 to 16 mm

Implant system	Drivers	∅	Final drills (Bone d4)	Final drills (Bone d3-d2-d1)	CSD (Bone d3 - d2)	TAP (d1 bone)
iMAX NHSI 3.3	HDH21S HDH21L	3.3	D2024M	D2428M	CSD33	TAPIMAX33
		3.7	D2428M	D2833M	CSD37	TAPS1B37
SHAPEONE B	HDH25S HDH25L	4.1	D2833M	D3338M	CSD41	TAPS1B41
		4.7	D3338M	D3844M	CSD47	TAPS1B47
		3.7	D2428M	D2833M	CSD37	TAPS1B37
SHAPEONE Tn	HDH25S HDH25L	4.1	D2833M	D3338M	CSD41	TAPS1B41
		4.7	D3338M	D3844M	CSD47	TAPS1B47
		3.7	D2428M	D2833M	CSD37	TAPiMAX37
iMAX NHSI	HDH25S HDH25L	4.1	D2833M	D3338M	CSD41	TAPiMAX41
		4.7	D3338M	D3844M	CSD47	TAPiMAX47
		5.2	D3844M	D4448M	CSD52	TAPiMAX52
		3.3	D2024M	D2428M	CSD33	TAPIMAX33
iMAX NHSIC Narrow	HDH21S HDH21L	3.7	D2428M	D2833M	CSD37	TAPiMAX37
		4.1	D2833M	D3338M	CSD41	TAPiMAX41
iMAX NHSIC Regular	HDH25S HDH25L	4.7	D3338M	D3844M	CSD47	TAPiMAX47
		5.2	D3844M	D4448M	CSD52	TAPiMAX52
		3.3	D2024M	D2428M	CSD33	
Volution SVB	HDH21S HDH21L	3.7	D2428M	D2833M	CSD37	
		4.1	D2833M	D3338M	CSD41	
		4.7	D3338M	D3844M	CSD47	
		5.2	D3844M	D4448M	CSD52	
iMAX NHSE 3.3	HDH24S HDH24L	3.3	D2024M	D2428M	CSD33	TAPIMAX33
		3.7	D2428M	D2833M	CSD37	TAPiMAX37
iMAX NHSE	HDH27S HDH27L	4.1	D2833M	D3338M	CSD41	TAPiMAX41
		4.7	D3338M	D3844M	CSD47	TAPiMAX47
		5.2	D3844M	D4448M	CSD52	TAPiMAX52
		3.7	D2428M	D2833M	CSD37	TAPS1B37
SHAPEONE T (abutment included in the pack)	HDH25S HDH25L	4.1	D2833M	D3338M	CSD41	TAPS1B41
		4.7	D3338M	D3844M	CSD47	TAPS1B47
		3.7	D2428M	D2833M	CSD37	TAPS1B37
SHAPEONE T (after removing the abutment tighten the implant)	HDH31S HDH31L	4.1	D2833M	D3338M	CSD41	TAPS1B41
		4.7	D3338M	D3844M	CSD47	TAPS1B47
		3.3	D2024M	D2428M	CSD33	TAPIMAX33
iMAXMUA 0°	NHSMDH NHSMFL (driver)	3.3	D2024M	D2428M	CSD33	TAPIMAX33
iMAXMUA 18°		3.7	D2428M	D2833M	CSD37	TAPiMAX37
iMAXMUA 30°		4.1	D2833M	D3338M	CSD41	TAPiMAX41
SHAPEMINI	HDH25M	2.7	D20M	D2024M		

## SHAPEONE

Ø 3.7

Sink countersink: up to 1.4mm for d3 medium bone/ up to 2.8mm for d2 medium bone and d1 compact bone  
Use 3.7 countersink and 3.7 tap



	Step 1	Step 2	Step 3	Step 4	Step 5	Step 6	Step 7	Step 8
Bone	Lance drill	Drill 2.0 2.4	Drill 2.4 2.8	Drill 2.8 3.3	Drill 3.3 3.8	Drill 3.8 4.4	Countersink	Tap
Soft d4	•	•	•					
Medium d3/d2	•	•	•	•			•	
Compact d1	•	•	•	•			•	•

## SHAPEONE

Ø 4.1

Sink countersink: up to 1.4mm for d3 medium bone/ up to 2.8mm for d2 medium bone and d1 compact bone  
Use 4.1 countersink and 4.1 tap

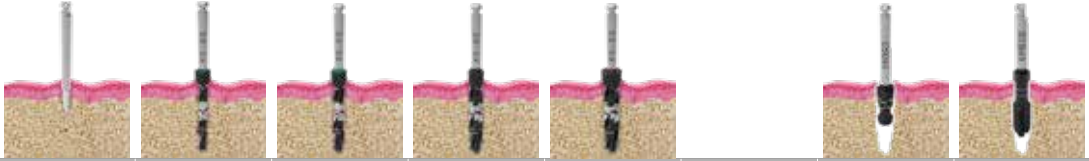

	Step 1	Step 2	Step 3	Step 4	Step 5	Step 6	Step 7	Step 8
Bone	Lance drill	Drill 2.0 2.4	Drill 2.4 2.8	Drill 2.8 3.3	Drill 3.3 3.8	Drill 3.8 4.4	Countersink	Tap
Soft d4	•	•	•	•				
Medium d3/d2	•	•	•	•	•		•	
Compact d1	•	•	•	•	•		•	•

## SHAPEONE

Ø 4.7

Sink countersink: up to 1.4mm for d3 medium bone/ up to 2.8mm for d2 medium bone and d1 compact bone  
Use 4.7 countersink and 4.7 tap



	Step 1	Step 2	Step 3	Step 4	Step 5	Step 6	Step 7	Step 8
Bone	Lance drill	Drill 2.0 2.4	Drill 2.4 2.8	Drill 2.8 3.3	Drill 3.3 3.8	Drill 3.8 4.4	Countersink	Tap
Soft d4	•	•	•	•	•			
Medium d3/d2	•	•	•	•	•	•	•	
Compact d1	•	•	•	•	•	•	•	•

**iMAX - iMAXMUA - iMAX NHSIC**

**Ø 3.3**

Sink countersink: up to 1.4mm for d3 medium bone/ up to 2.8mm for d2 medium bone and d1 compact bone  
Use 3.3 countersink and 3.3 tap



	Step 1	Step 2	Step 3	Step 4	Step 5	Step 6	Step 7	Step 8	Step 9
<b>Bone</b>	Lance drill	Drill 2.0 2.4	Drill 2.4 2.8	Drill 2.8 3.3	Drill 3.3 3.8	Drill 3.8 4.4	Drill 4.4 4.8	Countersink	Tap
Soft d4	•	•							
Medium d3/d2	•	•	•					•	
Compact d1	•	•	•					•	•

**iMAX - iMAXMUA - iMAX NHSIC**

**Ø 3.7**

Sink countersink: up to 1.4mm for d3 medium bone/ up to 2.8mm for d2 medium bone and d1 compact bone  
Use 3.7 countersink and 3.7 tap



	Step 1	Step 2	Step 3	Step 4	Step 5	Step 6	Step 7	Step 8	Step 9
<b>Bone</b>	Lance drill	Drill 2.0 2.4	Drill 2.4 2.8	Drill 2.8 3.3	Drill 3.3 3.8	Drill 3.8 4.4	Drill 4.4 4.8	Countersink	Tap
Soft d4	•	•	•						
Medium d3/d2	•	•	•	•				•	
Compact d1	•	•	•	•				•	•

**iMAX - iMAXMUA - iMAX NHSIC**

**Ø 4.1**

Sink countersink: up to 1.4mm for d3 medium bone/ up to 2.8mm for d2 medium bone and d1 compact bone  
Use 4.1 countersink and 4.1 tap



	Step 1	Step 2	Step 3	Step 4	Step 5	Step 6	Step 7	Step 8	Step 9
<b>Bone</b>	Lance drill	Drill 2.0 2.4	Drill 2.4 2.8	Drill 2.8 3.3	Drill 3.3 3.8	Drill 3.8 4.4	Drill 4.4 4.8	Countersink	Tap
Soft d4	•	•	•	•					
Medium d3/d2	•	•	•	•	•			•	
Compact d1	•	•	•	•	•			•	•

**iMAX - iMAX NHSIC**

Ø 4.7

Sink countersink: up to 1.4mm for d3 medium bone/ up to 2.8mm for d2 medium bone and d1 compact bone  
Use 4.7 countersink and 4.7 tap

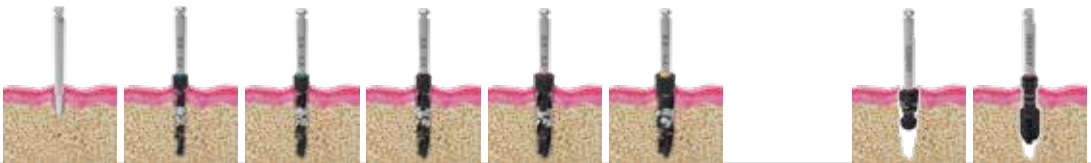

	Step 1	Step 2	Step 3	Step 4	Step 5	Step 6	Step 7	Step 8	Step 9
Bone	Lance drill	Drill 2.0 2.4	Drill 2.4 2.8	Drill 2.8 3.3	Drill 3.3 3.8	Drill 3.8 4.4	Drill 4.4 4.8	Countersink	Tap
Soft d4	•	•	•	•	•				
Medium d3/d2	•	•	•	•	•	•		•	
Compact d1	•	•	•	•	•	•		•	•

**iMAX - iMAX NHSIC**

Ø 5.2

Sink countersink: up to 1.4mm for d3 medium bone/ up to 2.8mm for d2 medium bone and d1 compact bone  
Use 5.2 countersink and 5.2 tap

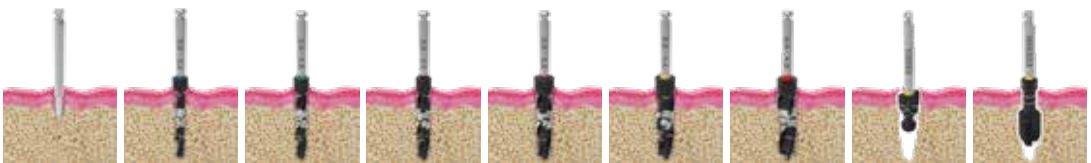

	Step 1	Step 2	Step 3	Step 4	Step 5	Step 6	Step 7	Step 8	Step 9
Bone	Lance drill	Drill 2.0 2.4	Drill 2.4 2.8	Drill 2.8 3.3	Drill 3.3 3.8	Drill 3.8 4.4	Drill 4.4 4.8	Countersink	Tap
Soft d4	•	•	•	•	•	•			
Medium d3/d2	•	•	•	•	•	•	•	•	
Compact d1	•	•	•	•	•	•	•	•	•

## VOLUTION

Ø 3.3

Sink countersink: up to 1.4mm for d3 medium bone/ up to 2.8mm for d2 medium bone and d1 compact bone  
Use 3.3 countersink



	Step 1	Step 2	Step 3	Step 4	Step 5	Step 6	Step 7	Step 8
Bone	Lance drill	Drill 2.0 2.4	Drill 2.4 2.8	Drill 2.8 3.3	Drill 3.3 3.8	Drill 3.8 4.4	Drill 4.4 4.8	Countersink
Soft d4	•	•						
Medium d3/d2	•	•	•					•
Compact d1	•	•	•					•

## VOLUTION

Ø 3.7

Sink countersink: up to 1.4mm for d3 medium bone/ up to 2.8mm for d2 medium bone and d1 compact bone  
Use 3.7 countersink



	Step 1	Step 2	Step 3	Step 4	Step 5	Step 6	Step 7	Step 8
Bone	Lance drill	Drill 2.0 2.4	Drill 2.4 2.8	Drill 2.8 3.3	Drill 3.3 3.8	Drill 3.8 4.4	Drill 4.4 4.8	Countersink
Soft d4	•	•	•					
Medium d3/d2	•	•	•	•				•
Compact d1	•	•	•	•				•

## VOLUTION

Ø 4.1

Sink countersink: up to 1.4mm for d3 medium bone/ up to 2.8mm for d2 medium bone and d1 compact bone  
Use 4.1 countersink



	Step 1	Step 2	Step 3	Step 4	Step 5	Step 6	Step 7	Step 8
Bone	Lance drill	Drill 2.0 2.4	Drill 2.4 2.8	Drill 2.8 3.3	Drill 3.3 3.8	Drill 3.8 4.4	Drill 4.4 4.8	Countersink
Soft d4	•	•	•	•				
Medium d3/d2	•	•	•	•	•			•
Compact d1	•	•	•	•	•			•

**VOLUTION**

Ø 4.7

Sink countersink: up to 1.4mm for d3 medium bone/ up to 2.8mm for d2 medium bone and d1 compact bone  
Use 4.7 countersink



	Step 1	Step 2	Step 3	Step 4	Step 5	Step 6	Step 7	Step 8
<b>Bone</b>	Lance drill	Drill 2.0 2.4	Drill 2.4 2.8	Drill 2.8 3.3	Drill 3.3 3.8	Drill 3.8 4.4	Drill 4.4 4.8	Countersink
Soft d4	•	•	•	•	•			
Medium d3/d2	•	•	•	•	•	•		•
Compact d1	•	•	•	•	•	•		•

**VOLUTION**

Ø 5.2

Sink countersink: up to 1.4mm for d3 medium bone/ up to 2.8mm for d2 medium bone and d1 compact bone  
Use 5.2 countersink

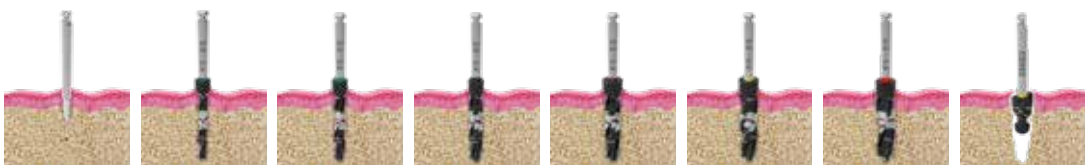

	Step 1	Step 2	Step 3	Step 4	Step 5	Step 6	Step 7	Step 8
<b>Bone</b>	Lance drill	Drill 2.0 2.4	Drill 2.4 2.8	Drill 2.8 3.3	Drill 3.3 3.8	Drill 3.8 4.4	Drill 4.4 4.8	Countersink
Soft d4	•	•	•	•	•	•		
Medium d3/d2	•	•	•	•	•	•	•	•
Compact d1	•	•	•	•	•	•	•	•

## ShapeOne

S1B

Ø	Heights
4.1	h 6.5 mm
4.7	

## ShapeOne

S1T - S1Tn

Ø	Heights
4.1	h 4.5 - 6.5 mm
4.7	

## iMAX

NHSI - NHSE

Ø	Heights
3.7	h 6.5 mm (NHSE only)
4.1	
4.7	h 6.5 mm
5.2	

## iMAX

NHSIC

Ø	Heights
4.1	h 6.5 mm
4.7	
5.2	

## Volution

SVB

Ø	Heights
3.7	h 6.5 mm
4.1	
4.7	
5.2	

Implant system	Drivers	Ø	Final drills (Bone d4)	Final drills (Bone d3-d2-d1)	CSD (Bone d3 - d2)	TAP (d1 bone)
SHAPEONE B	HDH25S	4.1	D3338M	D3844M	CSD41	TAPS1B41
	HDH25L	4.7	D3844M	D4448M	CSD47	TAPS1B47
SHAPEONE Tn	HDH25S	4.1	D3338M	D3844M	CSD41	TAPS1B41
	HDH25L	4.7	D3844M	D4448M	CSD47	TAPS1B47
iMAX NHSI	HDH25S HDH25L	3.7	D2833M	D3338M	CSD37	TAPiMAX37
		4.1	D3338M	D3844M	CSD41	TAPiMAX41
		4.7	D3844M	D4448M	CSD47	TAPiMAX47
		5.2	D4448M	D4448M	CSD52	TAPiMAX52
iMAX NHSIC Regular	HDH25S HDH25L	4.1	D3338M	D3844M	CSD41	TAPiMAX41
		4.7	D3844M	D4448M	CSD47	TAPiMAX47
		5.2	D4448M	D4448M	CSD52	TAPiMAX52
Volution SVB	HDH21S HDH21L	3.3	D2428M	D2833M	CSD33	
		3.7	D2833M	D3338M	CSD37	
	HDH25S HDH25L	4.1	D3338M	D3844M	CSD41	
		4.7	D3844M	D4448M	CSD47	
		5.2	D4448M	D4448M	CSD52	
iMAX NHSE	HDH27S HDH27L	3.7	D2833M	D3338M	CSD37	TAPiMAX37
		4.1	D3338M	D3844M	CSD41	TAPiMAX41
		4.7	D3844M	D4448M	CSD47	TAPiMAX47
		5.2	D4448M	D4448M	CSD52	TAPiMAX52
SHAPEONE T (abutment included in the pack)	HDH25S HDH25L	4.1	D3338M	D3844M	CSD41	TAPS1B41
		4.7	D3844M	D4448M	CSD47	TAPS1B47
SHAPEONE T (after removing the abutment tighten the implant)	HDH31S HDH31L	4.1	D3338M	D3844M	CSD41	TAPS1B41
		4.7	D3844M	D4448M	CSD47	TAPS1B47



## SHAPEONE

short implants

Ø 4.1

Sink countersink: up to 1.4mm for d3 medium bone/ up to 2.8mm for d2 medium bone and d1 compact bone  
Use 4.1 countersink and 4.1 tap



	Step 1	Step 2	Step 3	Step 4	Step 5	Step 6	Step 7	Step 8	Step 9
Bone	Lance drill	Drill 2.0 2.4	Drill 2.4 2.8	Drill 2.8 3.3	Drill 3.3 3.8	Drill 3.8 4.4	Drill 4.4 4.8	Countersink	Tap
Soft d4	•	•	•		•				
Medium d3/d2	•	•	•		•	•		•	
Compact d1	•	•	•		•	•		•	•

## SHAPEONE

short implants

Ø 4.7

Sink countersink: up to 1.4mm for d3 medium bone/ up to 2.8mm for d2 medium bone and d1 compact bone  
Use 4.7 countersink and 4.7 tap



	Step 1	Step 2	Step 3	Step 4	Step 5	Step 6	Step 7	Step 8	Step 9
Bone	Lance drill	Drill 2.0 2.4	Drill 2.4 2.8	Drill 2.8 3.3	Drill 3.3 3.8	Drill 3.8 4.4	Drill 4.4 4.8	Countersink	Tap
Soft d4	•	•	•	•		•			
Medium d3/d2	•	•	•	•		•	•	•	
Compact d1	•	•	•	•		•	•	•	•

## iMAX

short implants

Ø 3.7

Sink countersink: up to 1.4mm for d3 medium bone/ up to 2.8mm for d2 medium bone and d1 compact bone  
Use 3.7 countersink and 3.7 tap

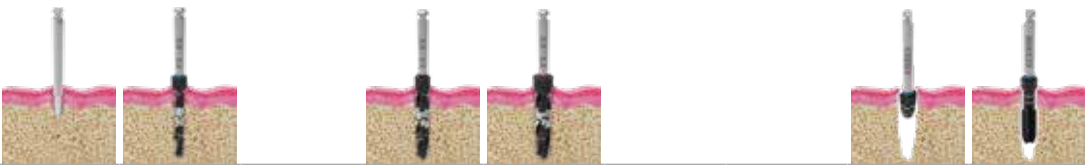

	Step 1	Step 2	Step 3	Step 4	Step 5	Step 6	Step 7	Step 8	Step 9
Bone	Lance drill	Drill 2.0 2.4	Drill 2.4 2.8	Drill 2.8 3.3	Drill 3.3 3.8	Drill 3.8 4.4	Drill 4.4 4.8	Countersink	Tap
Soft d4	•	•		•					
Medium d3/d2	•	•		•	•			•	
Compact d1	•	•		•	•			•	•

**iMAX - iMAX NHSIC**

short implants

Ø 4.1

Sink countersink: up to 1.4mm for d3 medium bone/ up to 2.8mm for d2 medium bone and d1 compact bone  
Use 4.1 countersink and 4.1 tap



	Step 1	Step 2	Step 3	Step 4	Step 5	Step 6	Step 7	Step 8	Step 9
Bone	Lance drill	Drill 2.0 2.4	Drill 2.4 2.8	Drill 2.8 3.3	Drill 3.3 3.8	Drill 3.8 4.4	Drill 4.4 4.8	Countersink	Tap
Soft d4	•	•	•		•				
Medium d3/d2	•	•	•		•	•		•	
Compact d1	•	•	•		•	•		•	•

**iMAX - iMAX NHSIC**

short implants

Ø 4.7

Sink countersink: up to 1.4mm for d3 medium bone/ up to 2.8mm for d2 medium bone and d1 compact bone  
Use 4.7 countersink and 4.7 tap



	Step 1	Step 2	Step 3	Step 4	Step 5	Step 6	Step 7	Step 8	Step 9
Bone	Lance drill	Drill 2.0 2.4	Drill 2.4 2.8	Drill 2.8 3.3	Drill 3.3 3.8	Drill 3.8 4.4	Drill 4.4 4.8	Countersink	Tap
Soft d4	•	•	•	•		•			
Medium d3/d2	•	•	•	•		•	•	•	
Compact d1	•	•	•	•		•	•	•	•

**iMAX - iMAX NHSIC**

short implants

Ø 5.2

Sink countersink: up to 1.4mm for d3 medium bone/ up to 2.8mm for d2 medium bone and d1 compact bone  
Use 5.2 countersink and 5.2 tap



	Step 1	Step 2	Step 3	Step 4	Step 5	Step 6	Step 7	Step 8	Step 9
Bone	Lance drill	Drill 2.0 2.4	Drill 2.4 2.8	Drill 2.8 3.3	Drill 3.3 3.8	Drill 3.8 4.4	Drill 4.4 4.8	Countersink	Tap
Soft d4	•	•	•	•	•		•		
Medium d3/d2	•	•	•	•	•		•	•	
Compact d1	•	•	•	•	•		•	•	•

**VOLUTION**

short implants

Ø 3.3

Sink countersink: up to 1.4mm for d3 medium bone/ up to 2.8mm for d2 medium bone and d1 compact bone  
Use 3.3 countersink

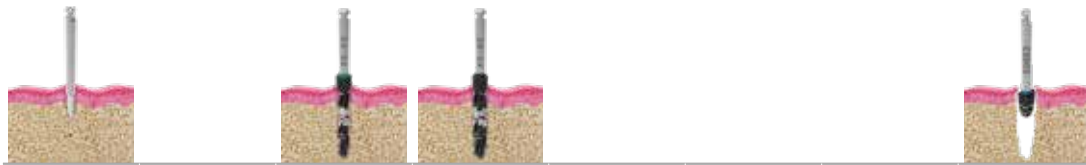

	Step 1	Step 2	Step 3	Step 4	Step 5	Step 6	Step 7	Step 8
Bone	Lance drill	Drill 2.0 2.4	Drill 2.4 2.8	Drill 2.8 3.3	Drill 3.3 3.8	Drill 3.8 4.4	Drill 4.4 4.8	Countersink
Soft d4	•		•					
Medium d3/d2	•		•	•				•
Compact d1	•		•	•				•

**VOLUTION**

short implants

Ø 3.7

Sink countersink: up to 1.4mm for d3 medium bone/ up to 2.8mm for d2 medium bone and d1 compact bone  
Use 3.7 countersink

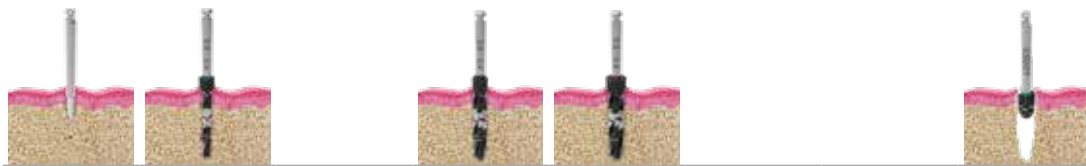

	Step 1	Step 2	Step 3	Step 4	Step 5	Step 6	Step 7	Step 8
Bone	Lance drill	Drill 2.0 2.4	Drill 2.4 2.8	Drill 2.8 3.3	Drill 3.3 3.8	Drill 3.8 4.4	Drill 4.4 4.8	Countersink
Soft d4	•	•		•				
Medium d3/d2	•	•		•	•			•
Compact d1	•	•		•	•			•

**VOLUTION**

short implants

Ø 4.1

Sink countersink: up to 1.4mm for d3 medium bone/ up to 2.8mm for d2 medium bone and d1 compact bone  
Use 4.1 countersink



	Step 1	Step 2	Step 3	Step 4	Step 5	Step 6	Step 7	Step 8
Bone	Lance drill	Drill 2.0 2.4	Drill 2.4 2.8	Drill 2.8 3.3	Drill 3.3 3.8	Drill 3.8 4.4	Drill 4.4 4.8	Countersink
Soft d4	•	•	•		•			
Medium d3/d2	•	•	•		•	•		•
Compact d1	•	•	•		•	•		•

**VOLUTION**

short implants

Ø 4.7

Sink countersink: up to 1.4mm for d3 medium bone/ up to 2.8mm for d2 medium bone and d1 compact bone  
Use 4.7 countersink



	Step 1	Step 2	Step 3	Step 4	Step 5	Step 6	Step 7	Step 8
Bone	Lance drill	Drill 2.0 2.4	Drill 2.4 2.8	Drill 2.8 3.3	Drill 3.3 3.8	Drill 3.8 4.4	Drill 4.4 4.8	Countersink
Soft d4	•	•	•	•		•		
Medium d3/d2	•	•	•	•		•	•	•
Compact d1	•	•	•	•		•	•	•

**VOLUTION**

short implants

Ø 5.2

Sink countersink: up to 1.4mm for d3 medium bone/ up to 2.8mm for d2 medium bone and d1 compact bone  
Use 5.2 countersink



	Step 1	Step 2	Step 3	Step 4	Step 5	Step 6	Step 7	Step 8
Bone	Lance drill	Drill 2.0 2.4	Drill 2.4 2.8	Drill 2.8 3.3	Drill 3.3 3.8	Drill 3.8 4.4	Drill 4.4 4.8	Countersink
Soft d4	•	•	•	•		•		
Medium d3/d2	•	•	•	•		•	•	•
Compact d1	•	•	•	•		•	•	•

## MINIMUM IMPLANTS SIZE ALLOWED FOR POSITION

iRES declines all responsibility in case of failure if the information leaflet, are not be respected as regard the implants position in relation to implants site and diameters

..... Implant head

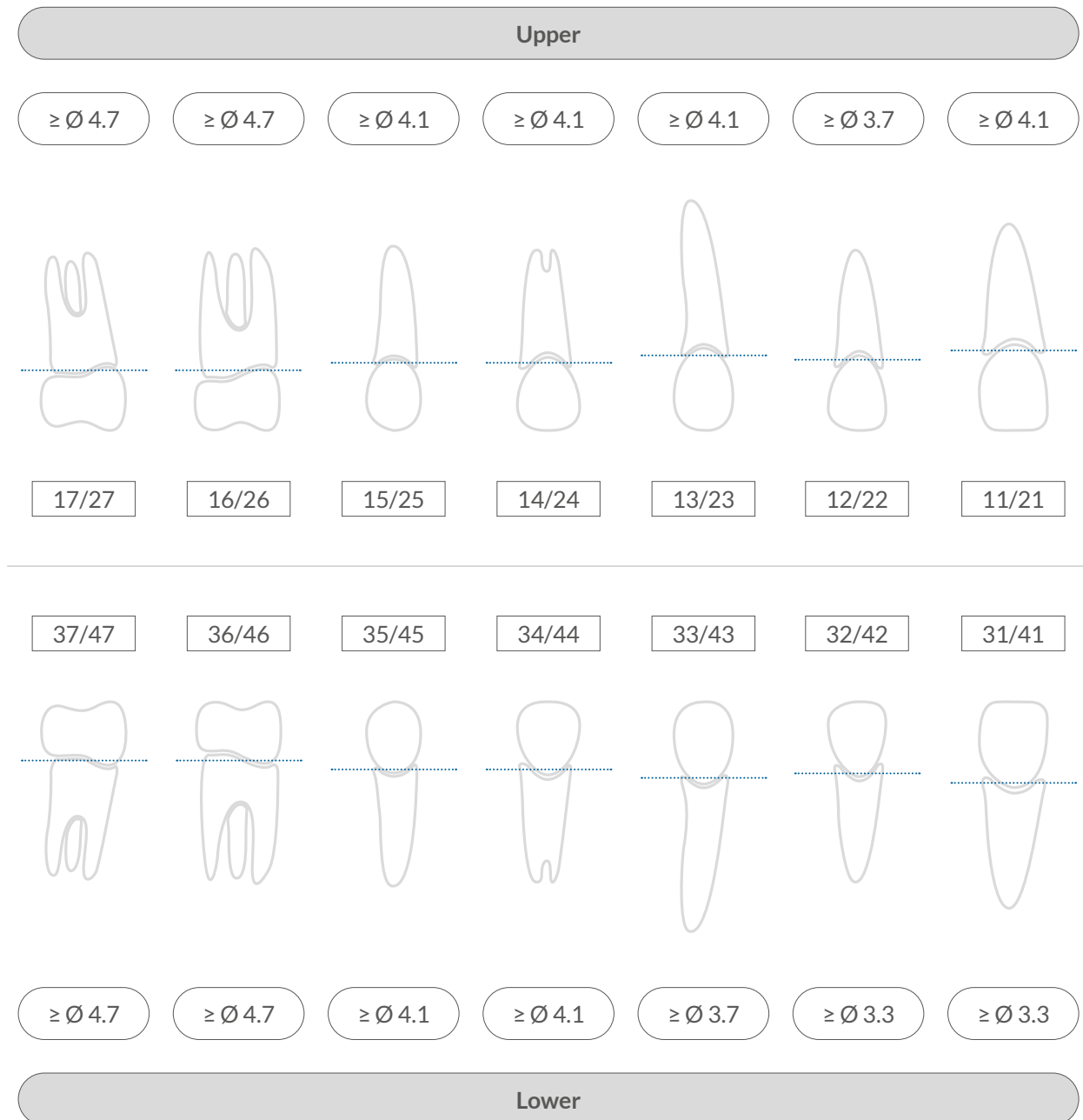

## NEW iRES® eShop

24/7

---

[www.eshop.ires.dental](http://www.eshop.ires.dental)

Sign up now and find out  
**all the benefits of online**  
shopping. You can easily  
order all our products  
thanks to a new clear,  
**simple and functional**  
graphical interface

---



### PRODUCT CHARACTERISTICS

The SHAPE1, IMAX, VOLUCTION, iMAXMUA and SHAPEMINI implant systems, by I-RES SAGL offers the dentist a wide choice of titanium implant configurations that differ in diameter, height and possibility of surgical positioning A) submerged/bone level, B) transmucose/tissue level, and various prosthetic components for the different rehabilitation procedures.

### Indications for use

The SHAPE1, IMAX, VOLUCTION, iMAXMUA and SHAPEMINI implant systems are indicated for surgical treatment in the upper or lower jaw for the partial or total replacement of teeth in patients who have lost part or all of their teeth. The implant to be used must be chosen by the medical personnel based on the medical history and on the subsequent surgical and prosthetic plan required for each individual patient. The onepiece implants iMAXMUA, having the same geometric shape of iMAX dental implants, ensure an excellent retention of the prosthesis, thanks to the ability to accommodate the retained screw designed for MUA components with a pitch of 1,72 mm instead of 1,4 mm as in the classic MUA. The implants are delivered in sterile packs and the operator must pay great attention when positioning it in the oral cavity, so that the implant does not come in contact with elements that could alter the surface, hindering the healing processes, so all manoeuvres must be performed in an environment suitable for surgical activities.

The SHAPE1, IMAX, VOLUCTION and iMAXMUA implant system has a series of dedicated surgical instruments for its implant lines, useful for the non-traumatic preparation of the site that is to receive the implant, and instruments designed for extracting the implant from the blister and transporting it to the mouth for insertion. Each blister containing the implant is provided with a closing screw, useful for sealing the internal part of the implant after it has been inserted in the mandibular or maxillary bone. SHAPEMINI implants fix the dentures but can also be used for the replacement of a single tooth.

### Contraindications

Do not use SHAPE1, IMAX, VOLUCTION, iMAXMUA and SHAPEMINI implant systems in patients who have a scarce amount of bone suitable to guarantee the primary stability of the implant in the first phase of insertion, in patients with poor oral hygiene, smokers, with uncontrolled systemic pathologies and blood disorders. In addition to the normal contraindications for general surgery, the conditions described above can have a negative influence on the partial or total integration of the implant.

### Warnings

To use the SHAPE1, IMAX, VOLUCTION, iMAXMUA and SHAPEMINI implant systems by I-RES SAGL, the dentist must know the general surgical and prosthetic techniques and the specific techniques for SHAPE1, IMAX, VOLUCTION, iMAXMUA and SHAPEMINI, following the indications of the surgical protocol and specific training courses. An incorrect choice of implant and surgical technique can be prejudicial to the success of the operation, causing the loss of the implant and of the surrounding bone. No implant must be used that has been used previously, or that has come in contact with the organic elements of third parties. The sterility of the implant is guaranteed by the sealed packaging and by correct storage in controlled dry environments; packages that are not intact or damaged are prejudicial to the use of the im-

plant. For product traceability it is important to keep the batch number marked on the implant package and on the adhesive labels to be found in the same package. For the same reason it is recommended that the dentist keep as possible his patients' medical files, in which he has a record of their medical history, treatment plans, types of operations and prosthetic rehabilitations performed and everything that can be useful for the patient's medical history. The use of non-original I-RES instruments is not advised, as is the failure to follow the indications for inserting the SHAPE1, IMAX, VOLUCTION, iMAXMUA and SHAPEMINI implant systems and the respective prosthetic components, because they have been designed to obtain the best result. SHAPE1, IMAX, VOLUCTION, iMAXMUA and SHAPEMINI implant systems must be inserted with a maximum torque of 50 Ncm, exceeding this force could be prejudicial to the precision of connection with the subsequent prosthetic part. The SHAPE1, IMAX, VOLUCTION, iMAXMUA and SHAPEMINI implant system includes, in its range, some implants with very small diameters (such as Ø 3.3 and Ø 2.7 mm for mini-implants) which must be used as implants only in the front of the mouth and not in diastoric areas where there is great masticatory stress. Especially the mini implants, with a Ø 2.7 mm, may be used only for the anchorage of the prosthesis. Furthermore, the implants with Ø 3.7 mm must not be inserted individually on premolars and molars, but at most should be only linked with bars to distribute the loading force.

SHAPEMINI mini-implants may be used only in the front part of the mouth for single tooth replacement and not in the rear part of the mouth where masticatory stress are higher, in this sites, they can only be used for dentures anchoring.

THE COMPANY I-RES SAGL DISCLAIMS HERSELF FOR ANY LIABILITY DUE TO THE NON OBSERVANCE OF THE INDICATIONS REPORTED IN THIS INSTRUCTION LEAFLET.

### Collateral effects

The known possible collateral effects are the partial or total failure of osseointegration, with consequent loss of the prosthetic function for which the implant system is intended, pain and transient paresthesia, fracture due to excessive load on the implant system, post or prosthesis.

### Pre-operative planning

The careful study and assessment of patients who are candidates for implant-prosthetic therapy is of fundamental importance. Physical, instrumental, and radiological examinations and the study of models allow the dentist to make the best diagnosis and consequent therapy. The preparation of the patient for surgical implant therapy and the preparation of the operating room must be given the same care and attention as general surgery; the preparation of the implant site using dedicated drills with controlled revolutions, cooled with saline solution, these are all indispensable conditions for implant therapy.

### Surgical complications

Implant surgery operations may lead to some complications that are usually temporary and restricted to the area of operation, such as inflammation, paresthesia, haematoma; there may also be injuries to nerves, to vascular complexes and the membrane of the maxillary sinus. Bone sequestration has rarely occurred.

### Materials and packaging













The SHAPE1, IMAX, VOLUCTION, iMAXMUA and

SHAPEMINI implant system is made of commercially pure grade 4 titanium (ASTM F67) and grade 5 titanium alloy (ASTM F136).

SHAPE1, IMAX, VOLUCTION, iMAXMUA and SHAPEMINI implants are surface treated to improve osseointegration by means of sandblasting followed by double acid-etching.

In the market are also available implants with different surface treatments depending on the intended use of the product, as well as implants with a final coating with hyaluronic acid for a better bone tissue healing. The only machined implants are suitable for the patient with periodontitis. The Hybrid implants (presenting a surface half machined and half superficially treated) are specified both for patients with periodontitis and for all those patients where stimulation is necessary to facilitate a rapid osseointegration aimed to reduce the real and possible insurgence of the periimplantitis. Decontamination is performed with cold Argon plasma followed by packaging in a cleanroom, for the final sterilisation phase with gamma or beta rays. The pack containing the implant and the respective cover screw must be opened in a sterile environment in the phases of surgical implant therapy. I-RES' SAGL implants are DISPOSABLE devices. Their reuse is not desirable from a medical, legal and ethical point of view. The use of not validated sterilization procedures can cause both the infection onset in the patient and impair the product performances. The failure compliance with these instructions implies a different use as provided by the manufacturer and those who make the reuse must take this action on their own responsibility.

### Symbols on the package

	Fabbricante - Manufactures iRES® SAGL Riva Caccia, 1/D 6900 Lugano [Switzerland] info@i-res-group.com www.i-res-group.com
	European Authorized Representative IESS GROUP SRL Via Madonna della Salute 23 - 33050 Pozzuolo del Friuli (UD) [Italy]
	CE Mark according to standard MDD93/42/EEC
	Batch number
	Use before the expiry date
	Sterilized by gamma or beta rays
	Do not reuse
	Do not restilize
	Follow the instructions given in the illustrative leaflet
	Do not expose to direct sunlight
	Do not expose to rain and keep in an environment free from damp
	Do not use if the packaging is damaged

The I-RES implant-prosthetic system is intended for use in the oral cavity and is provided with useful components to enable the dentist and the dental technician to prosthetically complete the operation begun by the dentist by inserting the implant in the patient. The I-RES implant-prosthetic system completes the line of I-RES dental implants and the respective I-RES instruments.

#### Product characteristics

**Healing screws.** The healing screw is a device used by the dentist to keep the oral mucosa pervious in the vicinity of the implant previously inserted. Once the soft tissues have healed, this will allow the dentist to perform the subsequent manoeuvres for prosthetization. The healing screws are made of grade 5 titanium.

**Transfer.** The transfer in grade 5 titanium is the instrument that allows the transfer from the mouth to a model of the information needed for the prosthetic connection and for making the respective prosthesis. There are two types of transfer: "closed tray and open tray", and they are all composed of two parts (a screw and a repositioner). After being inserted in the implant and secured to it with the screw, the transfer is ready to take the impression in the mouth.

**Analog.** The analog made of grade 5 titanium has the function of reproducing the internal characteristics of the implant and it must be securely fixed to the transfer. Once joined, the model can be cast.

**Straight, angled and millable posts.** They are made of grade 5 titanium; they have different shapes depending on the characteristics they have to satisfy, they are used mostly for prosthetic rehabilitations of bridges or crowns. The choice of the device that must be connected to the analog in the first phase is dictated by the clinical and processing decisions, which are at the discretion of the dentist and the dental technician.

**Plastic posts.** Plastic posts may be divided into two families, one for using directly in the oral cavity, appropriately modified and connected to the post to support temporary prostheses, one for the transformation of plastic posts into metal posts by the dental technician, with processing characteristics that are at the discretion of the dentist and the dental technician.

**Gold Bases.** These are components made of gold alloy and allow the creation of customized posts using overcasting techniques.

**Ball attachments.** Ball attachments are made of grade 5 titanium and, once fixed to the implants, they are able to act as an anchorage by means of special attachments to the patient's mobile prosthesis.

#### Contraindications:

Do not use I-RES products on patients who have allergies to the materials of which the component is made. The use of I-RES components in patients who have metabolic and periodontal diseases or poor oral hygiene may be prejudicial to the success of the

work, as may prosthetic constructions not in line with international standards. The lack of periodic controls, which the patient must undergo with his dentist after prosthetisation, may compromise the life of the implant-prosthetic system.

#### Warnings:

I-RES prosthetic components are reserved for use by personnel with knowledge of the subject. I-RES points out that alterations to the implant/post connections may be prejudicial to the success of the work, as may the failure to use original components. When using prosthetic components it is important to follow the instructions given by the dentist and the dental technician. When using prosthetic componen-

ts in the oral cavity it is important to respect the final tightening value which must be between 20 and 30 Ncm, as better specified in the catalogue.

#### Collateral effects

Today there are no known collateral effects in the use of I-RES components that can endanger the patient's health.

#### Prosthetic planning:

The choice of the I-RES components to be used for the case is the specific responsibility of the dentist and of the dental technician, depending on their requirements.

#### Materials and packaging:

All I-RES prosthetic components are packed in such a way as to be immediately identifiable, once removed from their pack; it is important for the operator to pay great attention in identifying them to avoid changes of position during work. It is useful to make note of the material batch used on the patient's file, for the purpose of traceability. Whether it has been processed or not, before inserting the I-RES prosthetic component in the oral cavity it is of fundamental importance that it be washed and sterilized. Some I-RES components are single-use, so intended for only one patient.

#### Cleaning | sterilization | storage:

**Caution !!! All prosthetic components for dental implants are sold NON-STERILE.**

Before use, all prosthetic components must be cleaned, disinfected and sterilized. These processes must also be performed before intraoral use, i.e. before each use for any test phases and in any case before final restoration loading. Repetition of the processes described in this paragraph does not alter the characteristics of these devices. Failure to follow these indications may lead to the onset of infections and complications for the implant and, more generally, for the patient. Important: care must be taken during the subsequent phases in preserving the zone of the connection with the implant (hexagon/octagon/threading).

#### a. Cleaning:

In case of automatic cleaning: use an ultrasound bath with a suitable detergent solution. Use neutral detergents only. Follow the manufacturer's instructions concerning concentrations and washing times. Use demineralised water to prevent the formation of stains and marks.

When cleaning manually: use a suitable neutral detergent and follow the manufacturer's user instructions. Brush the products with a soft-bristled brush (non-metal bristles) under running water. Use the brush to apply the detergent to all surfaces. Rinse with distilled water. After rinsing, dry the devices thoroughly and place them inside suitable sterilization bags.

#### b. Sterilization:

Place in a vacuum autoclave and sterilize as follows: Temperature = 121 - 124°C, with autoclave cycle of at least 20 minutes and drying cycle of 15 minutes.

#### c. Storage:

After sterilization, the product must remain in the sterilization bags. Only open the bags immediately prior to use. In normal conditions, sterilization bags maintain the sterility of the contents, unless the wrapping is damaged. Therefore, do not use components if the bags in which they were kept are damaged, and re-sterilizes in new bags before using them again. The storage time of products sterilized inside the bags should not exceed that recommended by the manufacturer of the bags.

The product must be stored in a cool dry place, away from direct sunlight, water and heat sources.

#### ATTENTION:

Some components such as transfers and healing screws are devices that can be reused after.









**CLEANING/STERILIZATION/STORAGE (follow the respective indications).**

**DO NOT REUSE a device classified as SINGLE-USE. Although it cannot be seen, it could be mechanically deformed or have been contaminated.**

#### Disposal procedures:

If removed from the oral cavity due to biological or mechanical failure, the prosthetic components must be disposed of as biological waste according to local regulations. More detailed information on the use of the medical device can be found in the specific Surgical Protocol available on the site [www.i-res-group.com](http://www.i-res-group.com) or in the IRES Shape1 catalogue supplied by the Manufacturer.

#### Symbols on the package:

	MANUFACTURER I-RES® SAGL Riva Caccia, 1/D 6900 Lugano (Switzerland) info@ires.dental www.ires.dental
	European Authorized Representative IESS GROUP SRL Via Madonna della Salute 23 - 33050 Pozzuolo del Friuli (UD) [Italy]
	CE Mark according to standard MDD93/42/EEC
	Batch number
	use before the expiry date
	Do not reuse
	Follow the instructions given in the illustrative leaflet
	Do not expose to direct sunlight
	Do not expose to rain and keep in an environment free from damp
	Do not use if the packaging is damaged
	not sterile



INSTRUCTIONS FOR IRES ROTARY INSTRUMENTS (DRILLS - COUNTERSINKS - TAPS) FOR THE PREPARATION OF THE SITE THAT HAS TO RECEIVE IRES@ SHAPE1@ IMPLANTS

**Product description:**

Dental drills, produced by I-RES Sagl, must be used as tools to perforate the bone. The diameters to be used, the lengths and the drilling sequence (number of drills to be used) are the sole choice and decision of the dentist, depending on the surgical protocol that must be followed. The maximum recommended speed is 800 rpm with saline solution applied directly on the drill to assist cooling.

- a) The sole purpose of the initial precision drill is to incise the cortical bone in a very precise point where it will later be drilled.
- b) The helical drills have laser markings for reference which identify the depth to be reached. Of course, in the use of this type of drill the manual skill and experience of the dental surgeon are extremely important, especially for stopping at the chosen depth.
- c) Countersinks are used when it is necessary to widen the initial part of the hole made to adapt the shape that of the neck of the implant to be inserted. The maximum recommended speed is 300 rpm with saline solution applied directly on the drill to assist cooling.
- d) Bone taps: in particularly dense bone (type I), before insertion it is advisable to use a bone tap with the same profile as the implant to be inserted. The bone tap has a greater cutting power than the implant, allowing the site to be prepared with reduced trauma. The maximum recommended speed is 30 rpm with saline solution applied directly on the bone tap to assist cooling.

**Materials used:**

All I-RES Sagl drills are made of medical grade steel and undergo hardening heat treatment. The maximum recommended number of uses of the devices is 40 times.

**Warnings and general precautions:**

- It is fundamental to respect the surgical protocol that establishes the diameters, lengths and the sequence of use. The operator is fully responsible for any uses other than those indicated.
  - Check that the drills to be used are in good condition, already cleaned and sterilized.
  - Check that the drills are in good condition and have not been used more than 40 times.
  - Before using them, check that the hand-piece holds the drills perfectly secure and that they rotate in the correct direction.
  - Ensure that there is adequate irrigation.
  - The application of leverage during drilling could cause breakage of the drill, the hand-piece, or the bone walls on which you are working.
- During drilling always exert alternating pressure, using the intermittent drilling technique.
- Always check that the laser marking that indicates diameter and length is clearly visible.
  - Any eccentricity or lack of straightness in the drill could result in an oversized hole.

- Wear eye protection, to protect against particles that may be ejected.

**CLEANING / STERILIZATION / STORAGE:**

The medical devices are supplied NON-STERILE.

Before use, all rotary devices must be cleaned, disinfected and sterilized.

Failure to follow these indications may lead to the onset of infections and complications for the implant and, more generally, for the patient.

**a. Cleaning**

In case of automatic cleaning: use an ultrasound bath with a suitable detergent solution. Use neutral detergents only. Follow the manufacturer's instructions concerning concentrations and washing times. Use demineralised water to prevent the formation of stains and marks.

When cleaning manually: use a suitable neutral detergent and follow the manufacturer's user instructions. Brush the products with a soft-bristled brush (non-metal bristles) under running water. Use the brush to apply the detergent to all surfaces. Rinse with distilled water. After rinsing, dry the devices thoroughly and place them inside suitable sterilization bags.

**b. Sterilization**

Place in a vacuum autoclave and sterilize as follows: Temperature = 121 – 124°C, with autoclave cycle of at least 20 minutes and drying cycle of 15 minutes.

**c. Storage**

After sterilization, the product must remain in the sterilization bags. Only open the bags immediately prior to use. In normal conditions, sterilization bags maintain the sterility of the contents, unless the wrapping is damaged. Therefore, do not use components if the bags in which they were kept are damaged, and re-sterilize in new bags before using them again. The storage time of products sterilized inside the bags should not exceed that recommended by the manufacturer of the bags. The product must be stored in a cool dry place, away from direct sunlight, water and heat sources.

More detailed information on the use of the medical device can be found in the Surgical Protocol. If you do not have a copy, request one from your distributor or directly from the manufacturer.

**Symbols on the package:**

 MANUFACTURER  
I-RES® SAGL Riva Caccia,  
1/D  
6900 Lugano [Switzerland]  
info@ires.dental  
www.ires.dental

 European Authorized Representative  
IESS GROUP SRL Via Madonna della  
Salute 23 - 33050 Pozzuolo del Friuli (UD)  
[Italy]

 CE Mark according to standard  
MDD93/42/EEC

 Batch number

 Follow the instructions  
given in the illustrative leaflet

 Do not expose to direct sunlight

 Do not expose to rain and keep in an  
environment free from damp

 Do not use if the packaging is  
damaged

 Not sterile



## CERTIFICATION

iRES® SAGL is a company with system EN ISO 13485 quality management whose quality standards are rigorously tested by the Notified Body. Process of on going FDA certification.



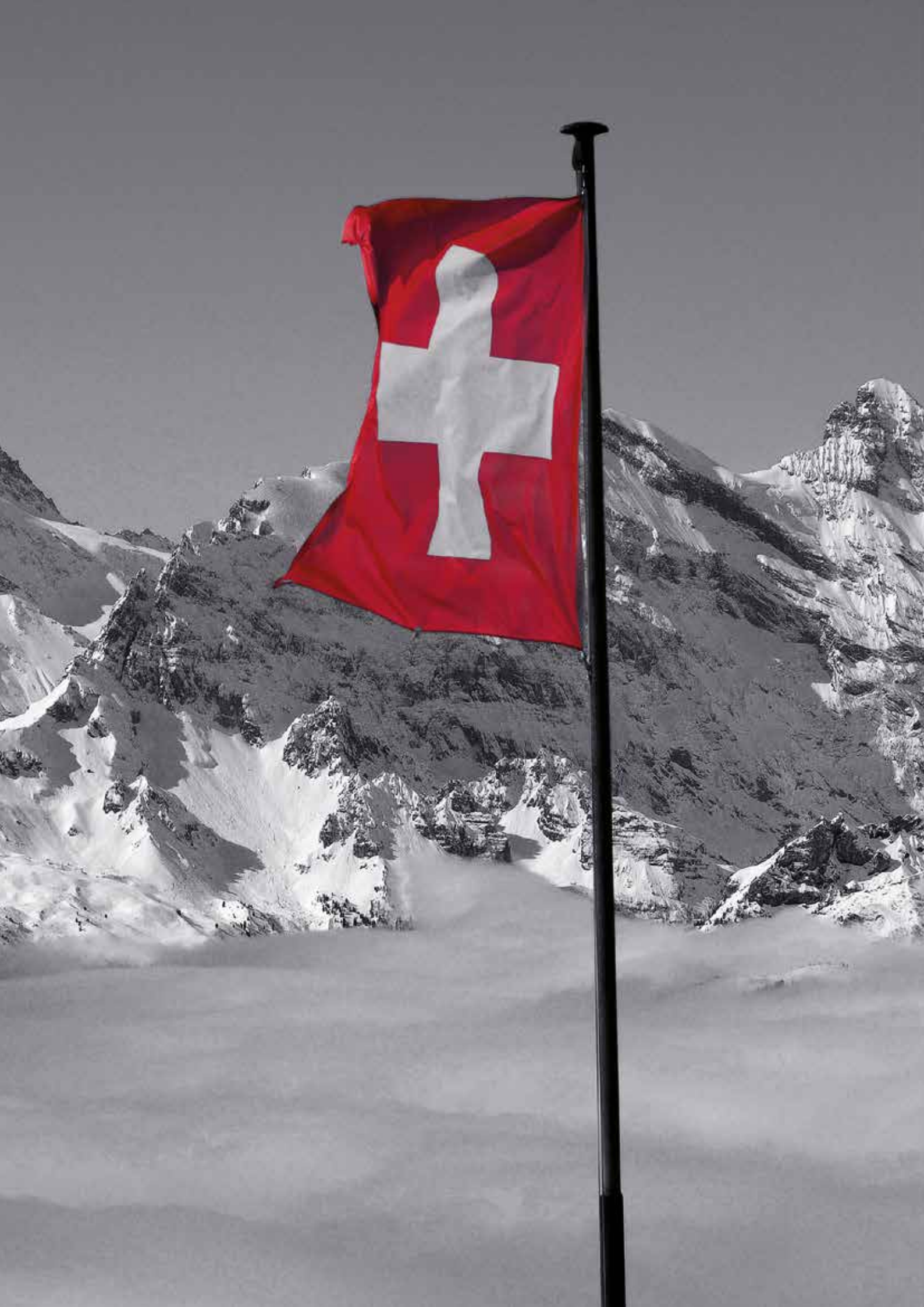



implant  
systems



prosthetic  
solutions



continuing  
education



guided  
surgery



regenerative  
materials



laser  
fixlite®

[info@ires.dental](mailto:info@ires.dental) | [www.ires.dental](http://www.ires.dental) | [eshop.ires.dental](http://eshop.ires.dental)

**ires**<sup>+</sup> | complete  
solutions  
for oral  
surgery

**IESS**  
GROUP  
DENTAL INTELLIGENCE

geass  
**ires**